

DO NOT SCALE DRAWING DIMENSION IN METRIC

DWG. NO. SD-35127-001

SIMILAR ITEM

PROJECT NO.

B

C

8 7 6 5 4 3 2 1

F
E
D
C
B
A

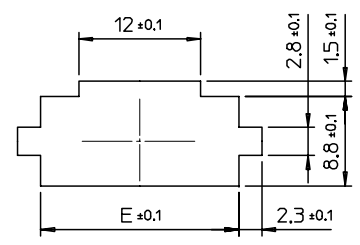
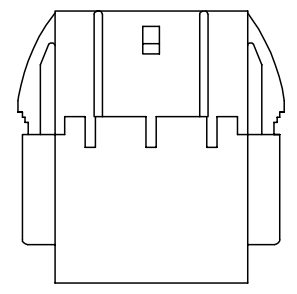
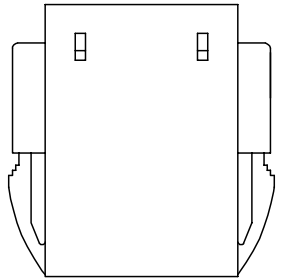
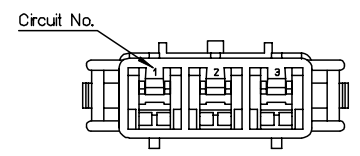

APPLICABLE PANNEL
THICKNESS : 1.2~2.0mm

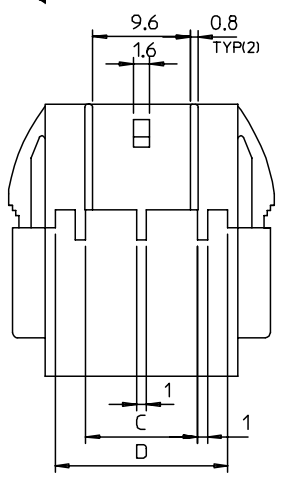
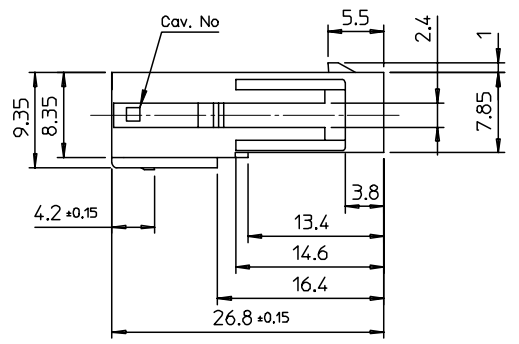
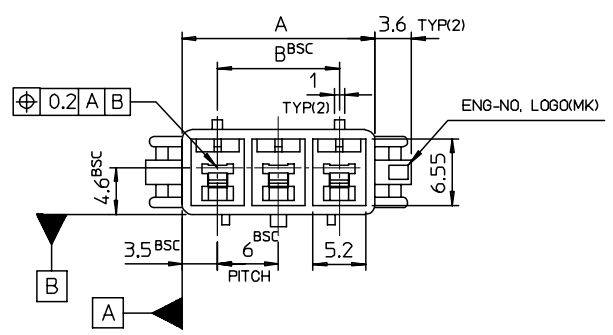

NOTES

1. MATERIALS: POLYESTER(PBT), UL94V-0, COLOR: NATURAL(WHITE)
2. DRAFT TO BE 0°30' UNLESS SPECIFIED.
3. WARPING TO BE 0.20 MAX.
4. PERMISSIBLE FLASH: 0.10MAX.
5. APPLICABLE MALE TERMINAL : 35040-****
6. MATED FEMALE HOUSING : 35128-****
7. PRODUCT SPECIFICATION : PS35127

25.5	23	11	18	25	351270400	35127-0400	4
19.5	17	11	12	19	351270300	35127-0300	3
13.5	11	5	6	13	351270200	35127-0200	2
E	D	C	B	A	MAT'L NO	ENG NO	CIRCUITS

REVISED ECN NO. KOR2000-0174 DRWN: Y.R.KIM 05.03.14 CHK: Y.SOO.KIM 05.03.14 APPR: C.W.LEE 05.03.14	QUALITY SYMBOLS MAJOR ▲ = 2 CRITICAL ◻ = *	GENERAL TOLERANCES: (UNLESS SPECIFIED)		SCALE 2:1	DESIGN UNITS <input checked="" type="checkbox"/> mm <input type="checkbox"/> INCH	THIRD ANGLE PROJECTION	DIMENSIONS: <input type="checkbox"/> mm <input checked="" type="checkbox"/> INCH <input type="checkbox"/> mm ONLY		SHT REV
		4 PLACES ±0.	±	3 PLACES ±0.	±	2 PLACES ±0.	±	1 PLACE ±0.2	±
C	REV	DRAFT WHERE APPLICABLE MUST REMAIN WITHIN DIMENSIONS		CAD FILENAME SD35127A_C.MI		MATERIAL NO. SEE TABLE	DRAWING NO. SD-35127-001	SHEET NO. 1 of 1	

8 7 6 5 4 3 2 1 KOREA MX-A3