



User Manual

AIMB-501

**Intel® Core™ i7/i5/i3/Celeron
and Pentium® LGA1155 Micro
ATX with VGA/DVI/LVDS, 10
COM, Dual Lan, 4 SATA II, 10
USB 2.0, PCIe x 16, PCIe x 1, 2
PCI**

ADVANTECH

Enabling an Intelligent Planet

Copyright

The documentation and the software included with this product are copyrighted 2012 by Advantech Co., Ltd. All rights are reserved. Advantech Co., Ltd. reserves the right to make improvements in the products described in this manual at any time without notice.

No part of this manual may be reproduced, copied, translated or transmitted in any form or by any means without the prior written permission of Advantech Co., Ltd. Information provided in this manual is intended to be accurate and reliable. However, Advantech Co., Ltd. assumes no responsibility for its use, nor for any infringements of the rights of third parties, which may result from its use.

Acknowledgements

IBM and PC are trademarks of International Business Machines Corporation.

Intel® Core™ i7/i5/i3, Pentium®, Celeron® is trademark of Intel Corporation

WinBond is a trademark of Winbond Corporation.

All other product names or trademarks are properties of their respective owners.

A Message to the Customer

Advantech Customer Services

Each and every Advantech product is built to the most exacting specifications to ensure reliable performance in the harsh and demanding conditions typical of industrial environments. Whether your new Advantech equipment is destined for the laboratory or the factory floor, you can be assured that your product will provide the reliability and ease of operation for which the name Advantech has come to be known.

Your satisfaction is our primary concern. Here is a guide to Advantech's customer services. To ensure you get the full benefit of our services, please follow the instructions below carefully.

Technical Support

We want you to get the maximum performance from your products. So if you run into technical difficulties, we are here to help. For the most frequently asked questions, you can easily find answers in your product documentation. These answers are normally a lot more detailed than the ones we can give over the phone.

So please consult this manual first. If you still cannot find the answer, gather all the information or questions that apply to your problem, and with the product close at hand, call your dealer. Our dealers are well trained and ready to give you the support you need to get the most from your Advantech products. In fact, most problems reported are minor and are able to be easily solved over the phone.

In addition, free technical support is available from Advantech engineers every business day. We are always ready to give advice on application requirements or specific information on the installation and operation of any of our products.

Declaration of Conformity

FCC Class B

This device complies with the requirements in part 15 of the FCC rules:

Operation is subject to the following two conditions:

- This device may not cause harmful interference
- This device must accept any interference received, including interference that may cause undesired operation.

This equipment has been tested and found to comply with the limits for a Class B digital device, pursuant to Part 15 of the FCC Rules. These limits are designed to provide reasonable protection against harmful interference when the equipment is operated in a commercial environment. This equipment generates, uses, and can radiate radio frequency energy and, if not installed and used in accordance with the instruction manual, may cause harmful interference to radio communications. Operation of this device in a residential area is likely to cause harmful interference in which case the user will be required to correct the interference at his/her own expense. The user is advised that any equipment changes or modifications not expressly approved by the party responsible for compliance would void the compliance to FCC regulations and therefore, the user's authority to operate the equipment.

Caution! *There is a danger of a new battery exploding if it is incorrectly installed. Do not attempt to recharge, force open, or heat the battery. Replace the battery only with the same or equivalent type recommended by the manufacturer. Discard used batteries according to the manufacturer's instructions.*



CPU Compatibility

Test Item	Description										Result	Remark
	CPU Family	sSpec.	Core Stepping	Power	Vcore	FSB	Mfg. Tech	HT	L2 cache	L3 cache		
Intel® Core™ i3-2120 Processor 3.3 GHz	SR05Y	Q0	65W		5 GT/s	32nm	NA	NA	3MB	LGA1155	PASS	
Intel® Core™ i5-2400 Processor 3.1GHz	SR00Q	D2	95W		5 GT/s	32nm	NA	NA	6MB	LGA1155	PASS	
Intel® Core™ i7-2600 Processor 3.4 GHz	SR00B	D2	95W		5 GT/s	32nm	NA	NA	8MB	LGA1155	PASS	
Intel® Celeron® Processor G540 2.50 GHz	SR05J		65W		5 GT/s	32nm	NA	NA	2MB	LGA1155	PASS	
Intel® Pentium® Processor G850 2.90 GHz	SR05Q		65W		5 GT/s	32nm	NA	NA	3MB	LGA1155	PASS	
Intel® Core™ i5-3550S Processor 3.0GHz	QC14	QS	65W			32nm	NA	NA	6MB	LGA1155	PASS	
Intel® Core™ i7-3770 Processor 3.4 GHz		QS	77W				NA	NA	6MB	LGA1155	PASS	

Memory Compatibility

Test Item	Description					Result	Remark
Brand	Size	Speed	Type	Vendor PN	Memory		
Transcend	1GB	DDR3 1066	DDR3	TS128MLK64V1U	SEC K4B1G0846G-BCH9	PASS	
	2GB	DDR3 1066	DDR3	TS256MLK64V1U	SEC K4B1G0846G-BCH9	PASS	
Apacer	1GB	DDR3 1066	DDR3	78.01GC3.420	ELPIDA J1108BDBG-DJ-F (128x8)	PASS	
	2GB	DDR3 1066	DDR3	78.A1GC3.421	ELPIDA J1108BDBG-DJ-F (128x8)	PASS	
	4GB	DDR3 1066	DDR3	78.B1GDJ.AF1	HYNIX H5TQ2G83BFR-H9C	PASS	
Transcend	1GB	DDR3 1333	DDR3	TS128MLK64V3U	ELPIDA EDJ1108BFBG-DJ-F	PASS	
	2GB	DDR3 1333	DDR3	TS256MLK64V3U	SEC K4B1G0846G-BCH9	PASS	
	8GB	DDR3 1333	DDR3	TS1GLK64V3H	MICRON IWD27 D9PBC	PASS	
Apacer	1GB	DDR3 1333	DDR3	78.01GC6.AF0	H5TQ1G83DFR-H9C	PASS	
	1GB	DDR3 1333	DDR3	78.01GC6.AF0	H5TQ1G83TFR-H9C	PASS	
	2GB	DDR3 1333	DDR3	78.A1GDE.4200C	ELPIDA J2108BCSE-DJ-F	PASS	
	2GB	DDR3 1333	DDR3	78.A1GDE.AF00C	Hynix H5TQ2G838FR(256x8)	PASS	
	4GB	DDR3 1333	DDR3	78.B1GDE.AF1	HYNIX H5TQ2G83BFR-H9C	PASS	
Kingston	2GB	DDR3 1333	DDR3	KVR1333D3S8N9/2G	ELPIDA J2108BCSE-DJ-F(128x8)	PASS	
	4GB	DDR3 1333	DDR3	KVR1333D3N9/4G	KINGSTON D2568JENC PGD9U(512x64)	PASS	
DSL	2GB	DDR3 1600	DDR3	D3US56081XH12AA	SEC 113 HCK0 K4B2G0846C 256x8	PASS	
	2GB	DDR3 1600	DDR3	D3US56082XH12AA	SEC 113 HCK0 K4B2G0846C 256x8	PASS	
Transcend	4GB	DDR3 1600	DDR3	TS512MLK64V6N	MICRON IUM22 D9PFJ	PASS	

Ordering Information

Part Number	CRT	DVI	LVDS	USB2.0	COM	TPM	LAN	PCIe x 1 slot	PCI slot	AMP	SUSI Access	Acronis	McAfee	Loyalty Label
AIMB-501G2-KSA1E	2	(1)	1	10	10	(1)	2	1	2	Yes (3W x 2)	v	v	v	v
AIMB-501L-KSA1E	1	0	0	10	2	(1)	1	1	0	No	v	v	v	v

*() not populated on MP version.

Product Warranty (2 years)

Advantech warrants to you, the original purchaser, that each of its products will be free from defects in materials and workmanship for two years from the date of purchase.

This warranty does not apply to any products which have been repaired or altered by persons other than repair personnel authorized by Advantech, or which have been subject to misuse, abuse, accident or improper installation. Advantech assumes no liability under the terms of this warranty as a consequence of such events.

Because of Advantech's high quality-control standards and rigorous testing, most of our customers never need to use our repair service. If an Advantech product is defective, it will be repaired or replaced at no charge during the warranty period. For out-of-warranty repairs, you will be billed according to the cost of replacement materials, service time and freight. Please consult your dealer for more details.

If you think you have a defective product, follow these steps:

1. Collect all the information about the problem encountered. (For example, CPU speed, Advantech products used, other hardware and software used, etc.) Note anything abnormal and list any onscreen messages you get when the problem occurs.
2. Call your dealer and describe the problem. Please have your manual, product, and any helpful information readily available.
3. If your product is diagnosed as defective, obtain an RMA (return merchandise authorization) number from your dealer. This allows us to process your return more quickly.
4. Carefully pack the defective product, a fully-completed Repair and Replacement Order Card and a photocopy proof of purchase date (such as your sales receipt) in a shippable container. A product returned without proof of the purchase date is not eligible for warranty service.
5. Write the RMA number visibly on the outside of the package and ship it prepaid to your dealer.

Initial Inspection

Before you begin installing your motherboard, please make sure that the following materials have been shipped:

- AIMB-501 Intel LGA1155 Core i7/i5/i3 Micro ATX Motherboard
- SATA HDD cable x 2
- I/O port bracket x 1
- Startup manual x 1
- Driver CD x 1
- Warranty card x 1
- COM port cable kit x 3

If any of these items are missing or damaged, contact your distributor or sales representative immediately. We have carefully inspected the AIMB-501 mechanically and electrically before shipment. It should be free of marks and scratches and in perfect working order upon receipt. As you unpack the AIMB-501, check it for signs of shipping damage. (For example, damaged box, scratches, dents, etc.) If it is damaged or it fails to meet the specifications, notify our service department or your local sales representative immediately. Also notify the carrier. Retain the shipping carton and packing material for inspection by the carrier. After inspection, we will make arrangements to repair or replace the unit.

Contents

Chapter 1 General Information1

1.1	Introduction	2
1.2	Features	2
1.3	Specifications	2
1.3.1	System	2
1.3.2	Memory	2
1.3.3	Input/Output	3
1.3.4	Graphics.....	3
1.3.5	Ethernet LAN	3
1.3.6	Industrial features	3
1.3.7	Mechanical and environmental specifications.....	3
1.4	Jumpers and Connectors	4
	Table 1.1: Jumpers.....	4
	Table 1.2: Connectors	4
1.5	Board layout: Jumper and Connector Locations	5
	Figure 1.1 Jumper and Connector Location	5
	Figure 1.2 I/O Connectors	5
1.6	AIMB-501 Board Diagram	6
	Figure 1.3 AIMB-501 Block Diagram	6
1.7	Safety Precautions	7
1.8	Jumper Settings	7
1.8.1	How to Set Jumpers.....	7
1.8.2	CMOS Clear (CMOS1)	8
	Table 1.3: CMOS1	8
1.8.3	JLVDS1: LCD Power 3.3 V/5 V/ 12 V Selector	8
	Table 1.4: JLVDS1: LCD Power 3.3 V/5 V/ 12 V Selector.....	8
1.8.4	JLVDS_VBR1: Backlight control selector for LVDS1	9
	Table 1.5: JLVDS_VBR1: Backlight control selector for LVDS1 .	9
1.8.5	PSON1: ATX, AT Mode Selector	9
	Table 1.6: PSON1: ATX, AT Mode Selector.....	9
1.8.6	JWDT1+JOBS1: Watchdog Timer Output and OBS Alarm Option.	9
	Table 1.7: JWDT1+JOBS1: Watchdog Timer Output and OBS Alarm Option.....	9
1.8.7	COM3/COM7 RS232/422/485 mode selector (JSETCOM3 & JSETCOM7).....	10
	Table 1.8: COM3 & COM7 RS 232/422/485 mode selector (JSETCOM3 & JSETCOM7)	10
1.8.8	CN1/CN2: Power setting for COM1 & COM2	10
	Table 1.9: CN1/CN2: Power setting for COM1 & COM2	10
1.8.9	JCASE1: Case Open Sensor	11
1.9	System Memory	11
1.10	Memory Installation Procedures.....	11
1.11	Cache Memory.....	11
1.12	Processor Installation	11

Chapter 2 Connecting Peripherals13

2.1	Introduction	14
2.2	USB Ports (LAN1_USB12/LAN2_USB34/USB01/USB23/USB45)	14
	Table 2.1: LAN LED Indicator.....	14
2.3	USB Power Switch	15
	Figure 2.1 HID-compliant Mouse Properties.....	15
2.4	VGA1/ DVI-D Connector (VGA1 + VGA2 + DVI1)	16

2.5	Serial Ports (COM1~COM10)	17
2.6	PS/2 Keyboard and Mouse Connector (KBMS1)/External PS/2 Keyboard and Mouse Connector (KBMS2)	18
2.7	CPU Fan Connector (CPU_FAN1)	19
2.8	System FAN Connector (SYSFAN1/2)	19
2.9	Front Panel Connectors (JFP1/JFP2/JFP3)	20
2.10	Line Out, Mic In Connector (AUDIO1)	21
2.11	SMBUS header (SMBUS1)	22
2.12	Serial ATA Interface (SATA1 ~ SATA4).....	22
2.13	Adjust audio volumn connector (VOL_ADJ1)	23
2.14	PCI express x16 slot	24
2.15	Front Headphone Connector (FPAUD1)	25
2.16	ATX Power Connector (EATXPWR1, ATX12V1).....	26
2.17	SPI Flash connector(SPI_CN1)	27
2.18	LCD Inverter Connector (INV1).....	28
2.19	LVDS Connector (LVDS1)	29
2.20	General Purpose I/O Connector (GPIO1)	29
2.21	LPC Connector for Debug (LPC1)	30

Chapter 3 BIOS Operation 31

3.1	Introduction	32
3.2	BIOS Setup	32
3.3	Main BIOS Setup	33
3.3.1	Advanced BIOS Features	34
3.3.2	PCI Configuration	35
3.3.3	PCI Express Settings.....	36
3.3.4	ACPI settings	37
3.3.5	Trusted Computing	38
3.3.6	S5 RTC wake Settings.....	38
3.3.7	SATA Configuration	39
3.3.8	Intel Trusted Execution Technology Configuration	39
3.3.9	USB Configuration	40
3.3.10	Super IO Configuration	41
3.3.11	Smart Fan Configuration.....	50
3.3.12	CPU PPM Configuration	52
3.4	Chipset Configuration Setting	52
3.4.1	PCH-IO Configuration	53
3.4.2	USB Configuration	57
3.4.3	PCH Azalia Configuration	58
3.4.4	System agent Configuration	58
3.4.5	NB PCIe Configuration	61
3.4.6	Memory Information.....	62
3.5	Boot Configuration	62
3.6	Security Setting.....	63
3.7	Save & Exit Configuration	64

Chapter 4 Chipset Software Installation Utility 67

4.1	Before You Begin.....	68
4.2	Introduction	68
4.3	Windows XP/Windows 7 Driver Setup	69

Chapter 5 VGA Setup 71

5.1	Introduction	72
5.2	Windows 7/XP.....	72

Chapter 6 LAN Configuration.....73

6.1	Introduction	74
6.2	Installation	74
6.3	Windows® 7/XP Driver Setup (Realtek RTL8111E-VL).....	74

Appendix A Programming the Watchdog Timer..75

A.1	Programming the Watchdog Timer	76
A.1.1	Watchdog Timer Overview.....	76
A.1.2	Programming the Watchdog Timer	76
	Table A.1: Watchdog Timer Registers	78
A.1.3	Example Program	79

Appendix B I/O Pin Assignments.....83

B.1	LAN&USB Connector (LAN1_USB12, LAN2_USB34).....	84
	Table B.1: LAN&USB Connector (LAN1_USB12, LAN2_USB34). 84	
B.2	USB Connector (USB01/23/45)	85
	Table B.2: USB Connector (USB01/23/45).....	85
B.3	USB/PS2 KBMS Power Setting (DUALPWR3/DUALPWR2)	85
	Table B.3: USB/PS2 KBMS Power Setting (DUALPWR3/ DUALPWR2)	85
B.4	VGA connector (VGA1/VGA2)	86
	Table B.4: USB Connector (USB01/23/45).....	86
B.5	DVI Connector (DVI1)	87
	Table B.5: DVI Connector (DVI1).....	87
B.6	COM Port Connector (COM1/COM2)	88
	Table B.6: COM Port Connector (COM1/COM2).....	88
B.7	COM Port Connector (COM3456/COM78910)	88
	Table B.7: COM Port Connector (COM3456/COM78910).....	89
B.8	KB/MS Connector (KBMS1).....	90
	Table B.8: KB/MS Connector (KBMS1)	90
B.9	KB/MS Header (KBMS2).....	90
	Table B.9: KB/MS Header (KBMS2)	90
B.10	CPU FAN Connector (CPU FAN1).....	91
	Table B.10:CPU FAN Connector (CPU FAN1)	91
B.11	System Fan Connector (SYS FAN1/SYS FAN2)	91
	Table B.11:System Fan Connector (SYS FAN1/SYS FAN2).....	91
B.12	Front Panel Connector (JFP1+JFP2).....	91
	Table B.12:Front Panel Connector (JFP1+JFP2)	92
B.13	Front Panel Connector (JFP3)	92
	Table B.13:Front Panel Connector (JFP3).....	92
B.14	Audio jack (AUDIO1).....	93
	Table B.14:Audio Jack (AUDIO1)	93
B.15	SM BUS Connector (SMBUS1).....	93
	Table B.15:SM BUS Connector (SMBUS1)	94
B.16	SATA Connector (SATA1/2/3/4)	94
	Table B.16:SATA Connector (SATA1/2/3/4).....	94
B.17	VOLT Connector (VOLT1)	94
	Table B.17:VOLT Connector (VOLT1).....	95
B.18	Front Audio Header (FPAUD1)	95
	Table B.18:Front Audio Header (FPAUD1).....	95
B.19	ATX 24-pin Power Connector (EATXPWR1)	96
	Table B.19:ATX 24-pin Power Connector (EATXPWR1).....	96
B.20	ATX 4-pin Power Connector (ATX12V1).....	97
	Table B.20:ATX 4-pin Power Connector (ATX12V1)	97

B.21	SPI Connector (SPI_CN1)	97
	Table B.21:SPI Connector (SPI_CN1).....	97
B.22	Inverter Power Output (INV1)	98
	Table B.22:Inverter Power Output (INV1).....	98
B.23	LVDS Connector (LVDS1)	98
	Table B.23:LVDS Connector (LVDS1)	98
B.24	GPIO Connector (GPIO1)	99
	Table B.24:GPIO Connector (GPIO1)	100
B.25	Debug Port (LPC1)	100
	Table B.25:Debug Port (LPC1).....	100
B.26	DMA Channel Assignments	101
	Table B.26:DMA Channel Assignments	101
B.27	Interrupt Assignments	101
	Table B.27:Interrupt Assignments	101
B.28	1st MB Memory Map	101
	Table B.28:1st MB Memory Map	101

Chapter 1

General Information

1.1 Introduction

AIMB-501 is designed with the Intel H61 for industrial applications that require both performance computing and enhanced power management capabilities. The motherboard supports Intel Core i7-3770 3.4 GHz/Core i5-3550S 3.0 GHz/Core i7-2600 3.4 GHz/Core i5-2400 3.1 GHz/Core i3-2120 3.3 GHz/ Pentium G850 2.9 GHz/Celeron G540 2.5 GHz processor up to 8 MB L3 cache and DDR3 1333/1600 up to 16 GB. It has rich I/O connectivity of 10 serial ports, 10 USB 2.0, dual GbE LAN and 4 SATA II ports.

1.2 Features

- **Rich I/O connectivity:** Dual GbE LAN via PCIe x 1 bus, 2 x PCI 32-bit/33 MHz PCI slots, 10 USB 2.0 ports, 10 serial ports, 1 PCIe x 16, and 1 PCIe x 1.
- **Standard Micro ATX form factor with industrial feature:** The AIMB-501 is a full featured Micro ATX motherboard with balanced expandability and performance.
- **Wide selection of storage devices:** SATA HDD, customers benefit from the flexibility of using the most suitable storage device for larger capacity.
- **Optimized integrated graphic solution:** With Intel® Flexible Display Interface, it supports versatile display options and 32-bit 3D graphics engine.

1.3 Specifications

1.3.1 System

- **CPU:** Intel Core i7-3770 3.4 GHz/Core i5-3550S 3.0GHz/Core i7-2600 3.4GHz/ Core i5-2400 3.1GHz /Core i3-2120 3.3GHz/ Pentium G850 2.9GHz/Celeron G540 2.5GHz processor
- **BIOS:** AMI EFI 64 Mbit SPI BIOS
- **System chipset:** Intel® H61
- **SATA hard disk drive interface:** Four on-board SATA connectors with data transmission rate up to 300 MB

1.3.2 Memory

- **RAM:** Up to 16 GB in 2 slots 240-pin DIMM sockets. Supports dual-channel DDR3 1333/1600 MHz SDRAM.
 - Supports non-ECC unbuffered DIMMs and do not support any memory configuration that mixes non-ECC with ECC unbuffered DIMMs.

Note! A 32-bit OS may not fully detected 16 GB of RAM when 16 GB is installed.



1.3.3 Input/Output

- **PCIe slot:** 1 PCIe x16 expansion slot and 1 PCIe x1 expansion slot.
- **PCIe Bus:** 2 PCI slots, 32-bit/33 MHz PCI 2.2 compliant
- **Parallel port:** Configured to LPT1 or disabled. LPT1 supports EPP/SPP/ECP.
- **Serial port:** Ten serial ports, two RS-232/422/485 with hardware auto-flow control and eight RS-232.
- **Keyboard and PS/2 mouse connector:** Two 6-pin mini-DIN connectors are located on the mounting bracket for easy connection to PS/2 keyboard and mouse.
- **USB port:** Supports up to 10 USB 2.0 ports with transmission rates up to 480 Mbps.
- **GPIO:** AIMB-501 supports 8-bit GPIO from super I/O for general purpose control application.

1.3.4 Graphics

- **Controller:** Intel® HD Graphics
- **Display memory:** 1 GB maximum shared memory with 2GB and above system memory installed
- **DVI:** Supports DVI up to resolution 1920 x 1200 @ 60Hz refresh rate
- **CRT1:** Supports VGA up to resolution 2048 x 1536 @ 75Hz refresh rate
- **CRT2:** Up to 1920 x 1200 resolution
- **LVDS:** Supports LVDS up to resolution 1600 x 1200

1.3.5 Ethernet LAN

- Supports dual 10/100/1000 Mbps Ethernet port (s) via PCI Express x1 bus which provides 500 MB/s data transmission rate
- **Controller:** LAN 1: Realtek 8111E-VL; LAN 2: Realtek 8111E-VL

1.3.6 Industrial features

- **Watchdog timer:** Can generate a system reset. The watchdog timer is programmable, with each unit equal to one second or one minute (255 levels)

1.3.7 Mechanical and environmental specifications

- **Operating temperature:** 0 ~ 60° C (32 ~ 140° F, depending on CPU)
- **Storage temperature:** -40 ~ 85° C (-40 ~ 185° F)
- **Humidity:** 5 ~ 95% non-condensing
- **Power supply voltage:** +3.3 V, +5 V, +12 V, -12 V, 5 Vsb
- **Power consumption:**
 - Intel LGA1155 Core i7-3770 3.4 GHz, 8MB L3 cache, 2pcs 8GB DDR3 1333 MHz, +5V @ 1.92A, +3.3V @ 1.03A, +12V @ 5.53A, 5Vsb @ 0.28A, -12V @ 0.11A
 - Measure the maximum current value which system under maximum load (CPU: Top speed, RAM: Full loading)
- **Board size:** 244 mm x 244 mm (9.6" x 9.6")
- **Board weight:** 0.5 kg

1.4 Jumpers and Connectors

Connectors on the AIMB-501 motherboard link it to devices such as hard disk drives and a keyboard. In addition, the board has a number of jumpers used to configure your system for your application.

The tables below list the function of each of the board jumpers and connectors. Later sections in this chapter give instructions on setting jumpers. Chapter 2 gives instructions for connecting external devices to your motherboard.

Table 1.1: Jumpers

Label	Function
CMOS1	Clear CMOS (Default 1-2)
JLVDS1	LVDS panel power setting
JLVDS_VBR1	Panel brightness control (Linear or PWM)
PSO1	AT mode (1-2); ATX mode (2-3)
JWDT1+JOBS1	Watchdog reset + OBS alarm
JSETCOM3/ JSETCOM7	COM3 & COM7 RS-232/422/485 jumper setting
CN1/CN2	5V (3-4); 12V (5-6)
JCASE1	Case open sensor

Table 1.2: Connectors

Label	Function
VGA1/VGA2	VGA1/VGA2 connector
DVI1	DVI connector
INV1	Inverter power output
LVDS1	LVDS connector
LANLED1	LAN LED
LAN1_USB12; LAN2_USB34	LAN & USB connector
FPAUD1	Front audio header
VOL_ADJ1	Adjust audio volume
AUDIO1	Line out /Mic in connector
SATA1/2/3/4	SATA1/2/3/4 on board connector
USB01/23/45	USB on board connector
SPI_CN1	SPI connector
LPC1	LPC connector for debug
LPT1	Print port
COM1/COM2	Serial port 1/2 on board connector
COM3456/COM78910	Serial port 3/4/5/6/7/8/9/10 on board connector
KBMS2	KB, MS header
CPU FAN1	CPU fan connector
SYS FAN1/SYS FAN2	System fan connector
GPIO1	GPIO connector
VOLT1	VOLT connector
JFP3	Front panel connector
JWDT1+JOBS1	Watchdog reset + OBS alarm
SMBUS1	SMBUS header

Table 1.2: Connectors

JFP1+JFP2	Power and reset button connector + HDD LED/SNMP Smbus/ speaker connector
-----------	---

1.5 Board layout: Jumper and Connector Locations

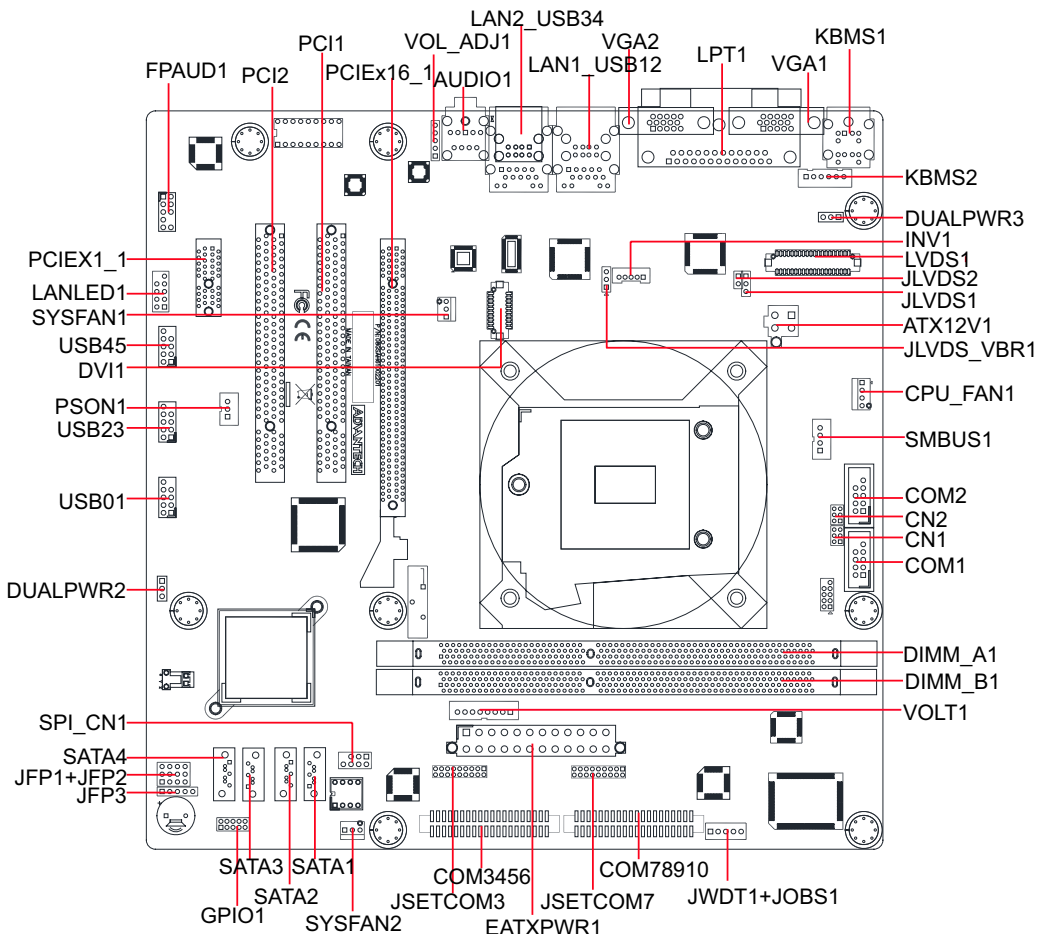

Figure 1.1 Jumper and Connector Location



Figure 1.2 I/O Connectors

1.6 AIMB-501 Board Diagram

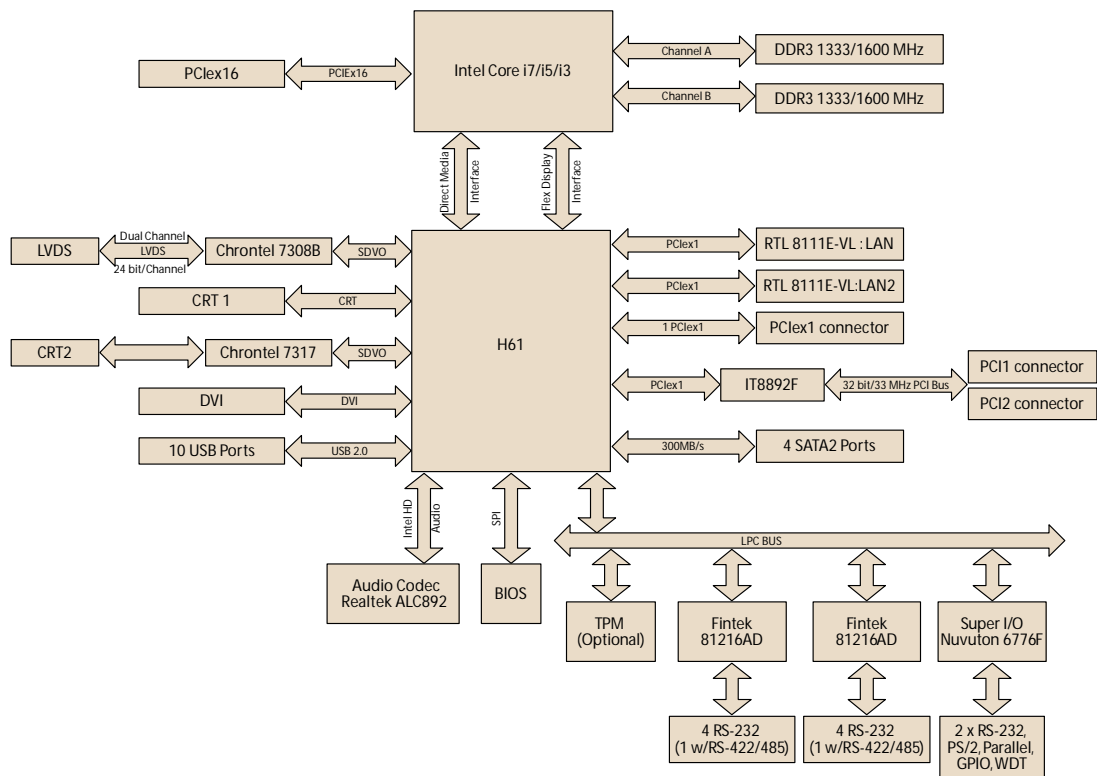

Figure 1.3 AIMB-501 Block Diagram

1.7 Safety Precautions

Warning! *Always completely disconnect the power cord from chassis whenever you work with the hardware. Do not make connections while the power is on. Sensitive electronic components can be damaged by sudden power surges. Only experienced electronics personnel should open the PC chassis.*



Caution! *Always ground yourself to remove any static charge before touching the motherboard. Modern electronic devices are very sensitive to electrostatic discharges. As a safety precaution, use a grounding wrist strap at all times. Place all electronic components on a static-dissipative surface or in a static-shielded bag when they are not in the chassis.*



Caution! *The computer is provided with a battery-powered real-time clock circuit. There is a danger of explosion if battery is incorrectly replaced. Replace only with same or equivalent type recommended by the manufacturer. Discard used batteries according to manufacturer's instructions.*



Caution! *There is a danger of a new battery exploding if it is incorrectly installed. Do not attempt to recharge, force open, or heat the battery. Replace the battery only with the same or equivalent type recommended by the manufacturer. Discard used batteries according to the manufacturer's instructions.*



1.8 Jumper Settings

This section provides instructions on how to configure your motherboard by setting the jumpers. It also includes the motherboards's default settings and your options for each jumper.



1.8.1 How to Set Jumpers

You can configure your motherboard to match the needs of your application by setting the jumpers. A jumper is a metal bridge that closes an electrical circuit. It consists of two metal pins and a small metal clip (often protected by a plastic cover) that slides over the pins to connect them. To “close” (or turn ON) a jumper, you connect the pins with the clip. To “open” (or turn OFF) a jumper, you remove the clip. Sometimes a jumper consists of a set of three pins, labeled 1, 2, and 3. In this case you connect either pins 1 and 2, or 2 and 3. A pair of needle-nose pliers may be useful when setting jumpers.

1.8.2 CMOS Clear (CMOS1)

The AIMB-501 motherboard contains a jumper that can erase CMOS data and reset the system BIOS information. Normally this jumper should be set with pins 1-2 closed. If you want to reset the CMOS data, set CMOS1 to 2-3 closed for just a few seconds, and then move the jumper back to 1-2 closed. This procedure will reset the CMOS to its default setting.

Table 1.3: CMOS1

Function	Jumper Setting
*Keep CMOS data	 1-2 closed
Clear CMOS data	 2-3 closed

* Default

1.8.3 JLVD51: LCD Power 3.3 V/5 V/ 12 V Selector

Table 1.4: JLVD51: LCD Power 3.3 V/5 V/ 12 V Selector

Closed Pins	Result
JLVD51	
2-3	Jumper for 5V LVDS panel
1-2	Jumper for 3.3V LVDS panel*
2-2	Jumper for 12V LVDS panel

*Default

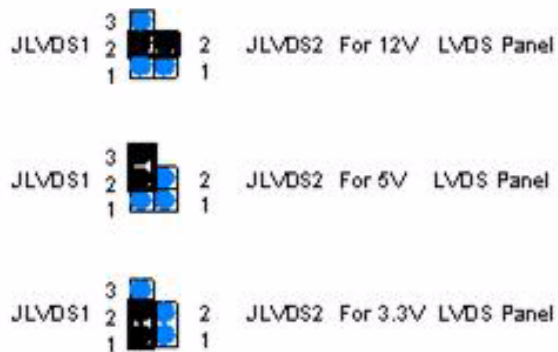

1.8.4 JLVD5_VBR1: Backlight control selector for LVDS1

Table 1.5: JLVD5_VBR1: Backlight control selector for LVDS1

Closed Pins	Result
1-2*	Linear brightness control
2-3	PWM brightness control

*Default

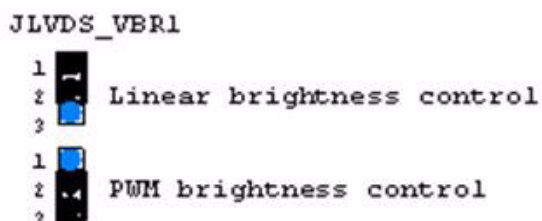

1.8.5 PSON1: ATX, AT Mode Selector

Table 1.6: PSON1: ATX, AT Mode Selector

Closed Pins	Result
1-2	AT Mode
2-3*	ATX Mode

*Default



1.8.6 JWDT1+JOBS1: Watchdog Timer Output and OBS Alarm Option

Table 1.7: JWDT1+JOBS1: Watchdog Timer Output and OBS Alarm Option

Closed Pins	Result
1-2	NC
*2-3	Reset
*4-5	Enable OBS function (4-5 open: disable OBS function)



*: Default

1.8.7 COM3/COM7 RS232/422/485 mode selector (JSETCOM3 & JSETCOM7)

Users can use JSETCOM3 & JSETCOM7 to select among RS232/422/485 mode for COM3 & COM7. The default setting is RS232.

Table 1.8: COM3 & COM7 RS 232/422/485 mode selector (JSETCOM3 & JSETCOM7)

Function	Jumper Setting
*RS232	(5-6) + (7-9) + (8-10) + (13-15) + (14-16) closed
RS422	(3-4) + (9-11) + (10-12) + (15-17) + (16-18) closed
RS-485	(1-2) + (9-11) + (10-12) + (15-17) + (16-18) closed
*: Default	

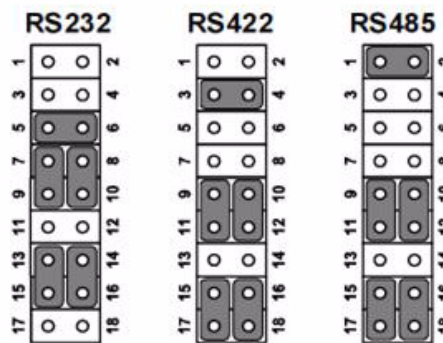

1.8.8 CN1/CN2: Power setting for COM1 & COM2

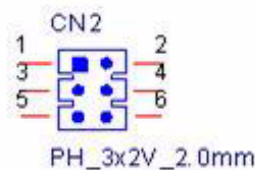
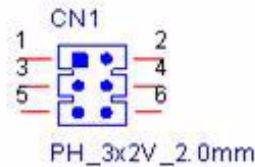

(Default)

Table 1.9: CN1/CN2: Power setting for COM1 & COM2

Setting	Function
1-2	No power
3-4	with 5V
5-6	with 12V

1.8.9 JCASE1: Case Open Sensor

The AIMB-501 motherboard contains a jumper that provides a chassis open sensor. The buzzer on the motherboard beeps when the case is opened.

1.9 System Memory

AIMB-501 has two 240-pin memory sockets for 1333/1600 MHz memory modules with maximum capacity of 16GB (Maximum 8GB for each DIMM). AIMB-501 supports only non-ECC DDR3 memory modules.

1.10 Memory Installation Procedures

To install DIMMs, first make sure the two handles of the DIMM socket are in the “open” position, i.e., the handles lean outward. Slowly slide the DIMM module along the plastic guides on both ends of the socket. Then firmly but gently (avoid pushing down too hard) press the DIMM module well down into the socket, until you hear a click when the two handles have automatically locked the memory module into the correct position of the DIMM socket. To remove the memory module, just push both handles outward, and the memory module will be ejected by the mechanism.

1.11 Cache Memory

The AIMB-501 supports a CPU with one of the following built-in full speed L3 caches:

8 MB for Intel Core i7-3770

6 MB for Intel Core i5-3550S

3 MB for Intel Core i3-3220

8 MB for Intel Core i7-2600

6 MB for Intel Core i5-2400

3 MB for Intel Core i3-2120

3 MB for Intel Pentium G850

2 MB for Intel Celeron G540

The built-in second-level cache in the processor yields much higher performance than conventional external cache memories.

1.12 Processor Installation

The AIMB-501 is designed for LGA1155, Intel Core i7/Core i5/Core i3/Pentium/Celeron processor.

Chapter 2

Connecting
Peripherals

2.1 Introduction

You can access most of the connectors from the top of the board as it is being installed in the chassis. If you have a number of cards installed or have a packed chassis, you may need to partially remove the card to make all the connections.

2.2 USB Ports (LAN1_USB12/LAN2_USB34/USB01/USB23/USB45)

The AIMB-501 provides up to 10 USB ports. The USB interface complies with USB Specification Rev 2.0 supporting transmission rates up to 480 Mbps. The USB interface can be disabled in the system BIOS setup.

The AIMB-501 is equipped with two high-performance 1000 Mbps Ethernet LAN adapters, both of which are supported by all major network operating systems. The RJ-45 jacks on the rear panel provides convenient LAN connection.

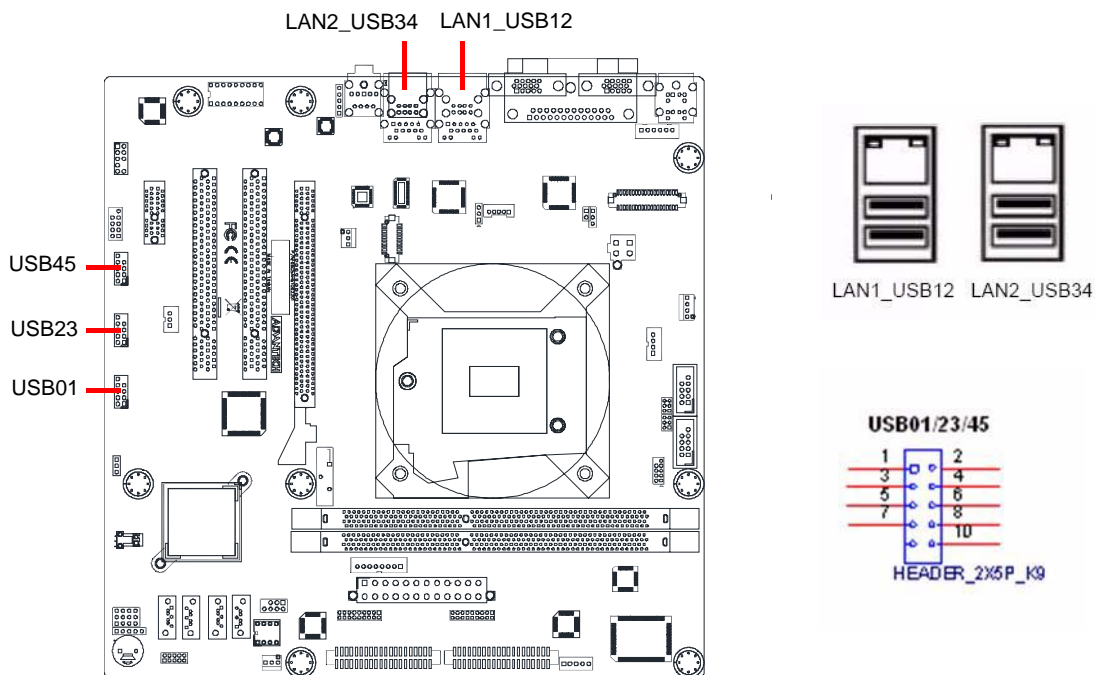

Table 2.1: LAN LED Indicator

LAN Mode	LAN Indicator	
LAN1 indicator	LED1 (Right)	off for mal-link; Link (On) / Active (Flash)
	LED2 (Left)	100 Mbps (On) / 10 Mbps (Off)
	LED2 (Left)	1000 Mbps (On)
LAN2 indicator	LED1 (Right)	off for mal-link; Link (On) / Active (Flash)
	LED2 (Left)	100 Mbps (On) / 10 Mbps (Off)
	LED2 (Left)	1000 Mbps (On)

2.3 USB Power Switch

AIMB-501 allows users to set USB power between +5VSB and +5V. When the jumper is set as 2-3, do not tick "Allow this device to bring the computer out of standby" under device manager (as below figure 2.1) if users do not request to have the board wake up from S3 via USB device keyboard or mouse.

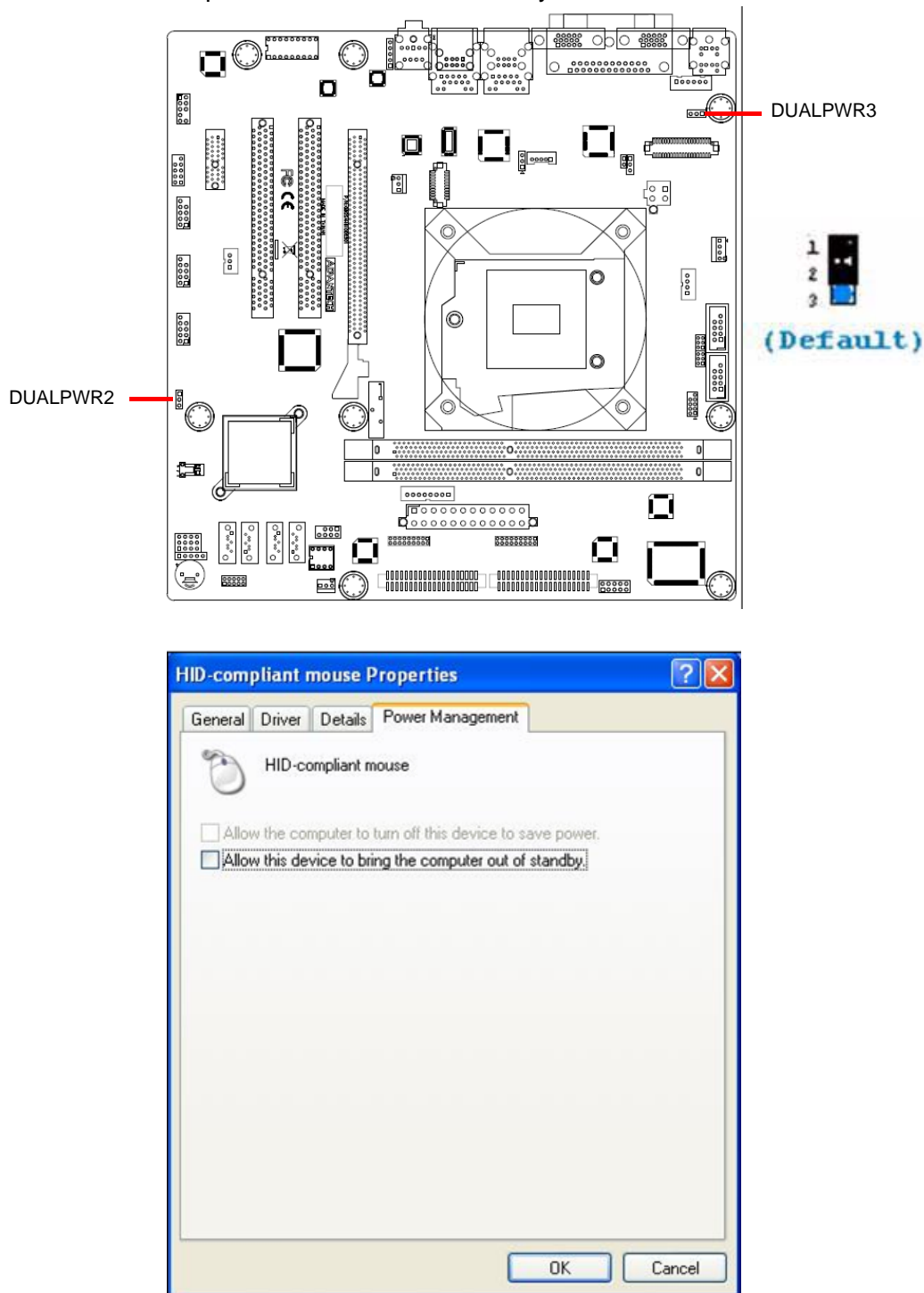

Figure 2.1 HID-compliant Mouse Properties

DUALPWR3/DUALPWR2	USB/PS2 KBMS Power setting
Setting	Function
1-2	USB/PS2 KBMS power from MOS
2-3	USB/PS2 KBMS power from +5V

DUALPWR2- Jumper for on board USB

DUALPWR3- Jumper for rear side USB & PS/2 KBMS

Note! When USB power is switched to +5V, it can't be connected with power KVM.



2.4 VGA1/ DVI-D Connector (VGA1 + VGA2 + DVI1)

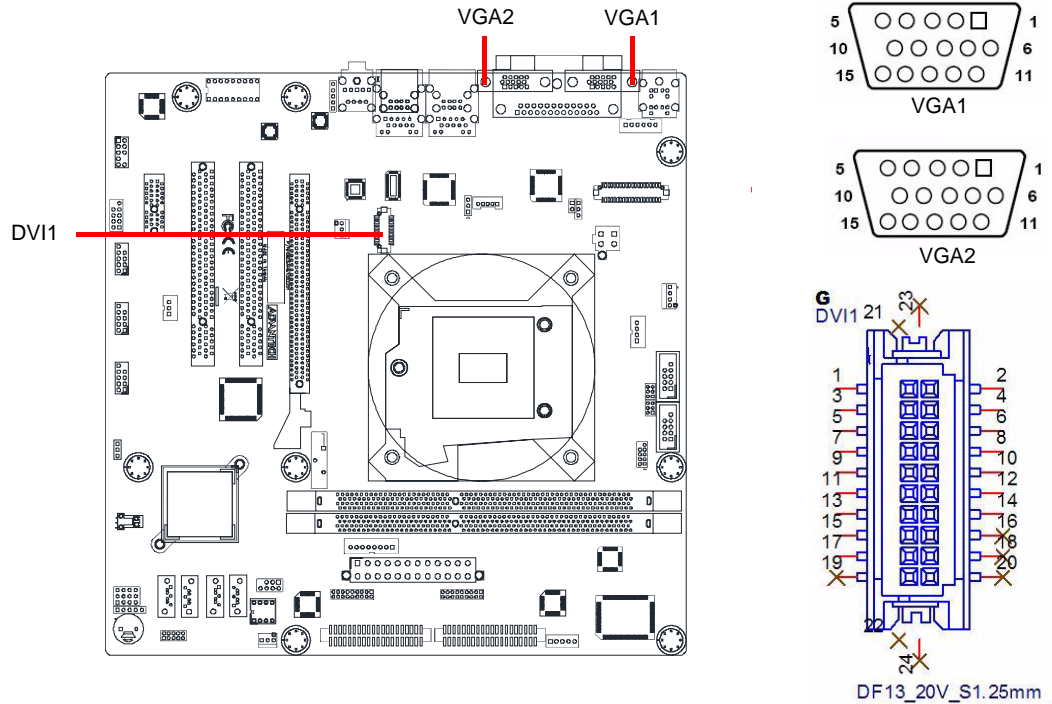

AIMB-501 includes VGA and DVI interfaces that can drive conventional VGA and DVI displays. VGA is a standard 15-pin D-SUB connector commonly used for VGA. Pin assignments for VGA and DVI connectors are detailed in Appendix B.

2.5 Serial Ports (COM1~COM10)

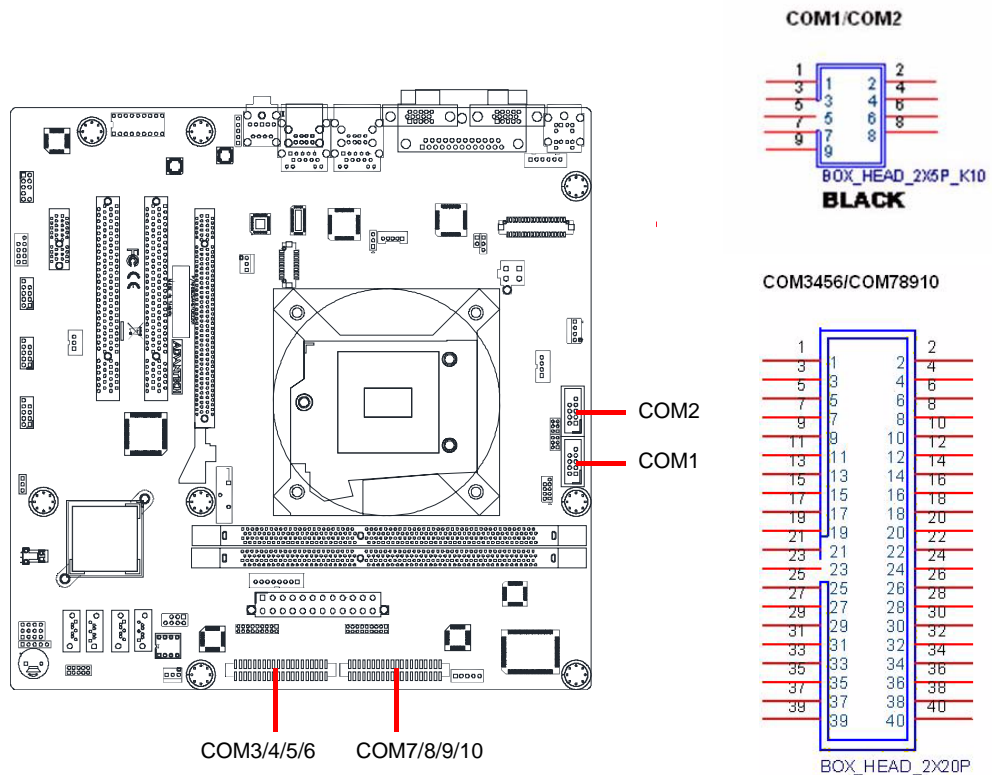

AIMB-501 supports ten serial ports. COM1. COM2. COM4-6. COM8-10 supports RS-232. COM3 & COM7 supports RS-232/422/485 (supports RS-485 auto flow control). JSETCOM3 & JSETCOM7 is used to select the RS-232/422/485 mode for COM3 & COM7. COM1 & COM2 is with selectable 5V/12V power..

These ports can connect to serial devices, such as a mouse or a printer, or to a communications network.

The IRQ and address ranges for both ports are fixed. However, if you want to disable the port or change these parameters later, you can do this in the system BIOS setup.

Different devices implement the RS-232 standards in different ways. If you have problems with a serial device, be sure to check the pin assignments for the connector.

2.6 PS/2 Keyboard and Mouse Connector (KBMS1)/ External PS/2 Keyboard and Mouse Connector (KBMS2)

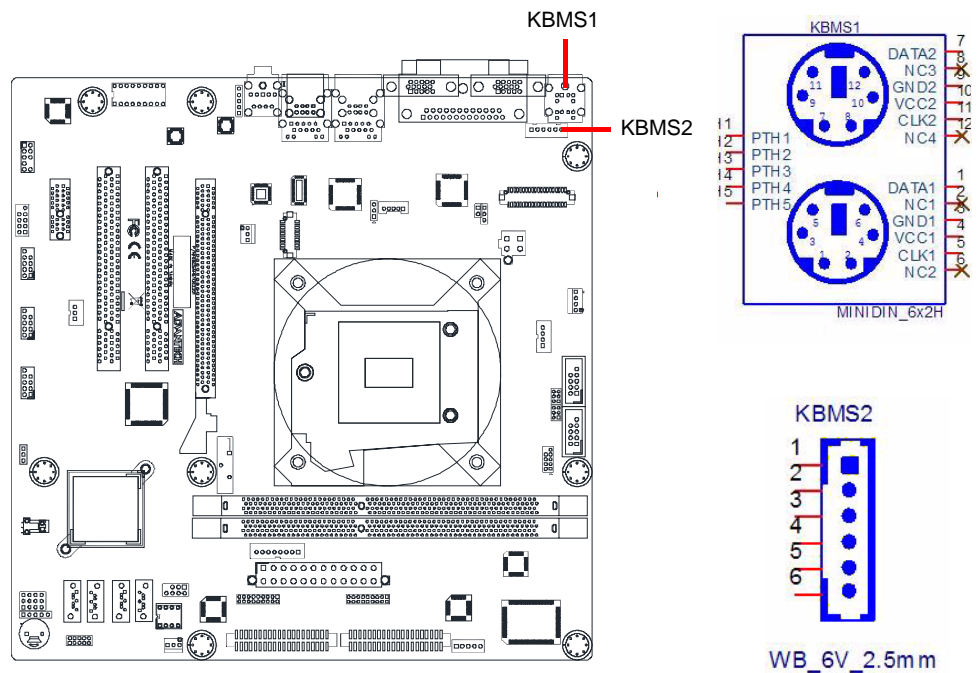

Two 6-pin mini-DIN connectors (KBMS1) on the motherboard provide connection to a PS/2 keyboard and a PS/2 mouse, respectively. KBMS2 is for supporting the 2nd PS/2 keyboard and PS/2 mouse by a cable P/N 1700018699.

2.7 CPU Fan Connector (CPU_FAN1)

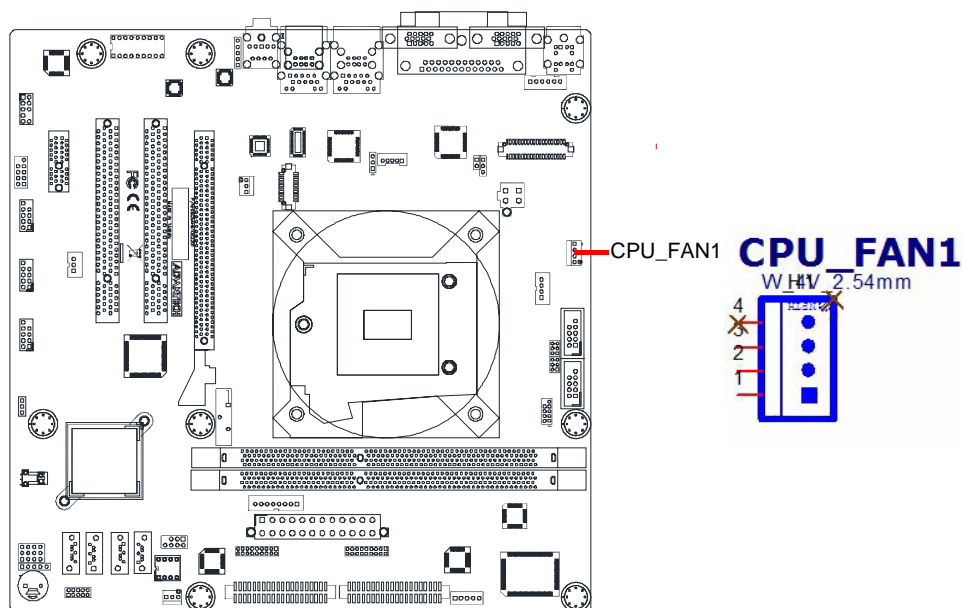

If a fan is used, this connector supports cooling fans of 500 mA (6 W) or less.

2.8 System FAN Connector (SYSFAN1/2)

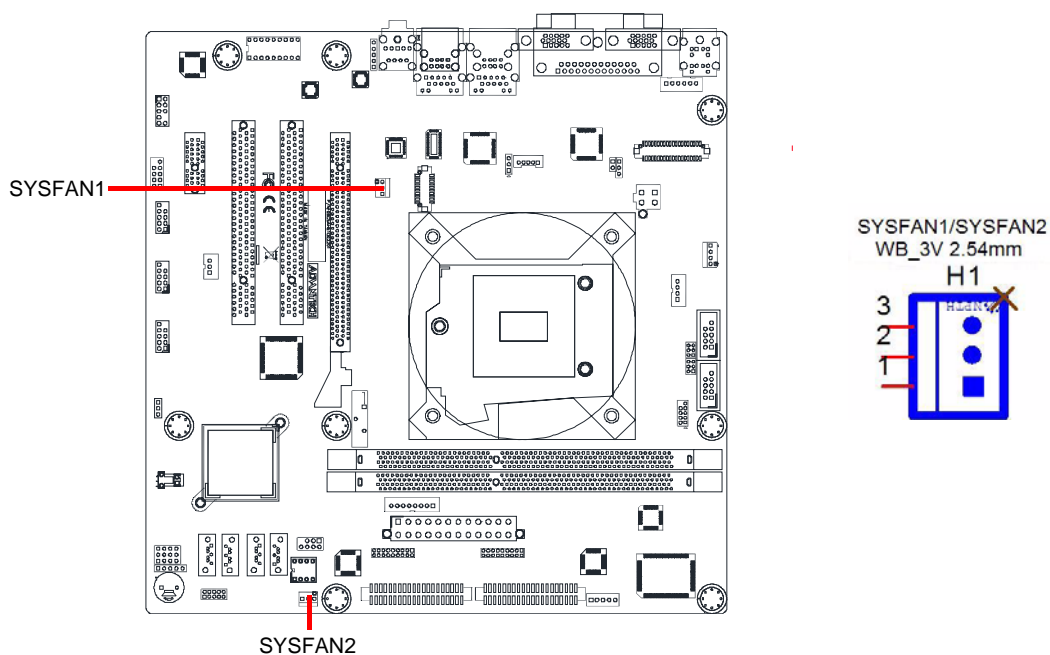

If a fan is used, this connector supports cooling fans of 500 mA (6 W) or less.

2.9 Front Panel Connectors (JFP1/JFP2/JFP3)

There are several headers for monitoring and controlling the AIMB-501.

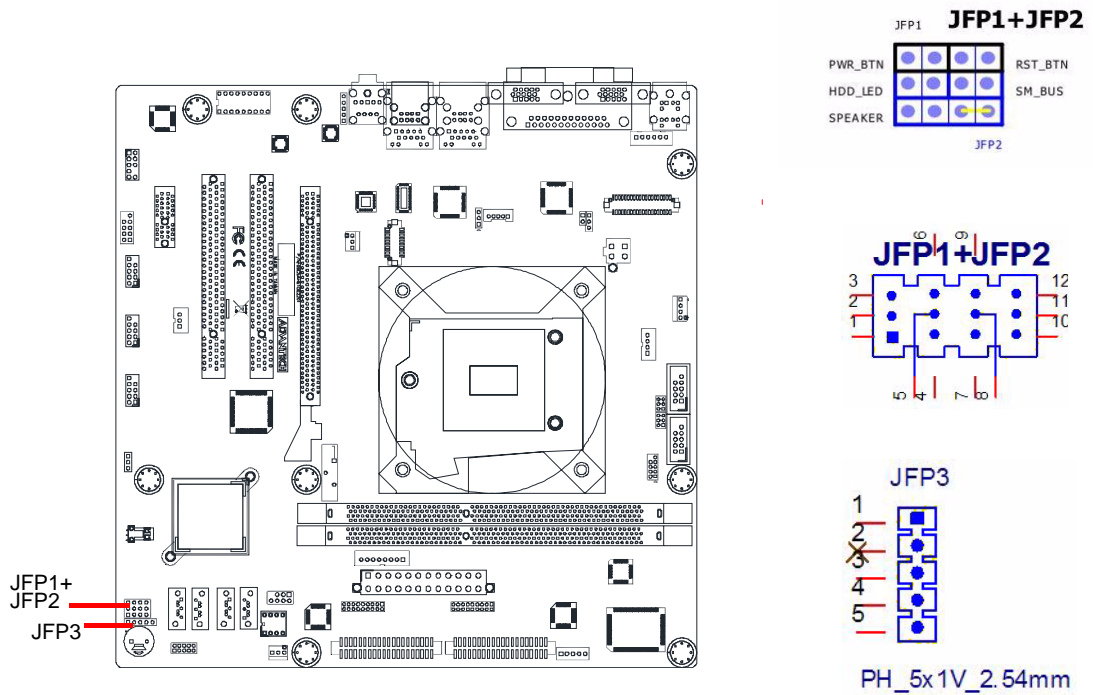

JFP3	Front panel connector
Pin	Pin Name
1	SIO_SUSLED
2	NC
3	GND
4	#KEYLOCK
5	GND

2.10 Line Out, Mic In Connector (AUDIO1)

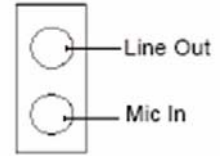
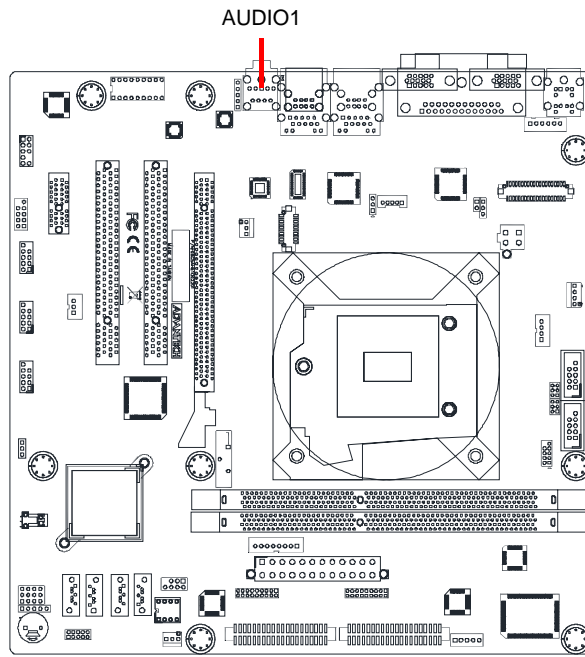

2.11 SMBUS header (SMBUS1)

AIMB-501 provides SMBUS connector for customer connection to SMBUS protocol embedded device. It can be configured to I2C by customer's request.

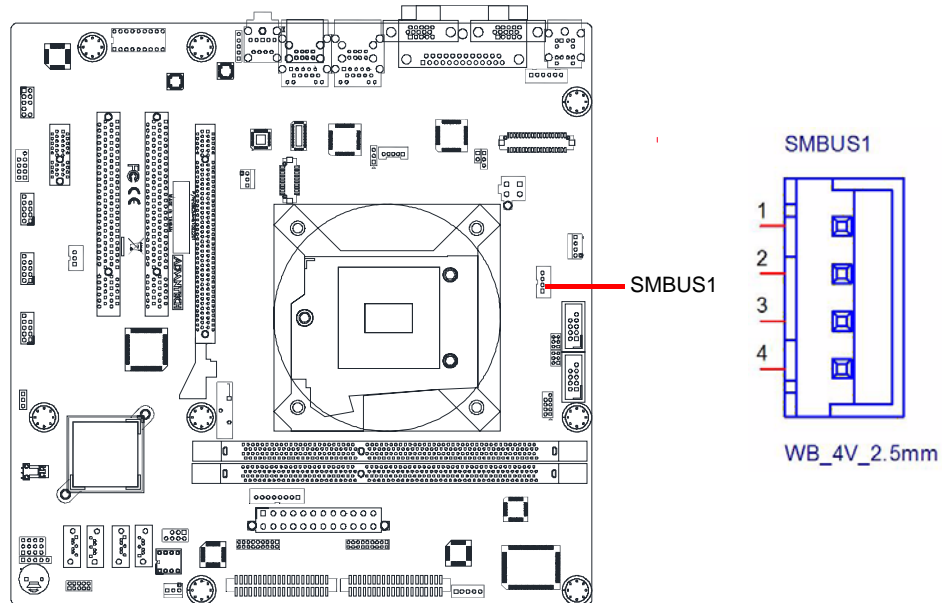

2.12 Serial ATA Interface (SATA1 ~ SATA4)

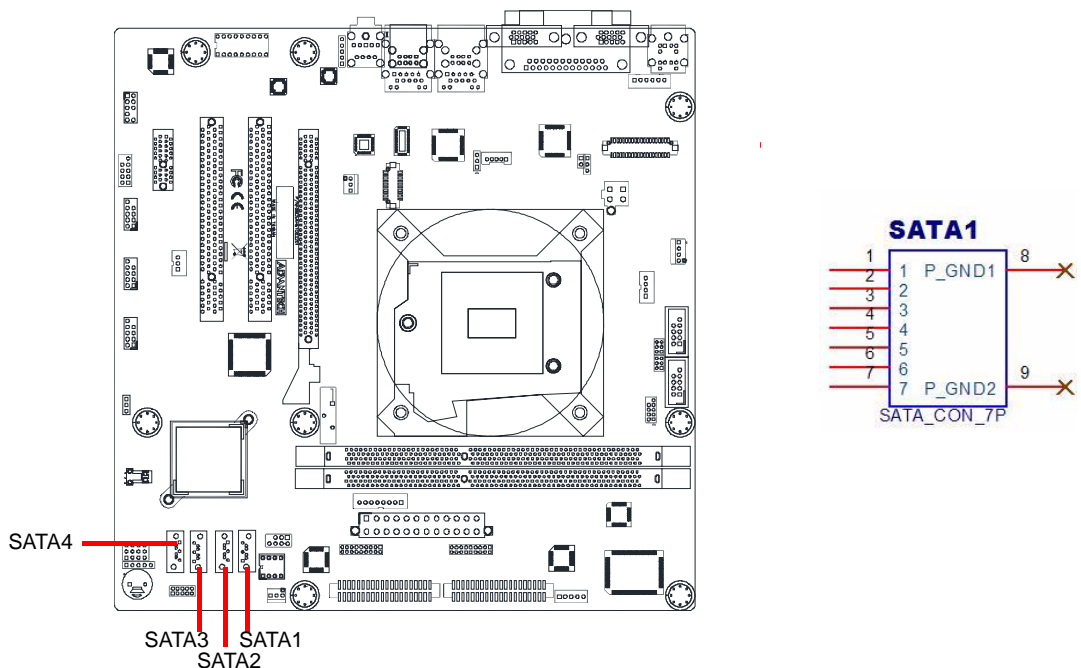

AIMB-501 features a high performance Serial ATA interface (up to 300 MB/s) which eases hard drive cabling with thin, space-saving cables.

2.13 Adjust audio volumn connector (VOL_ADJ1)

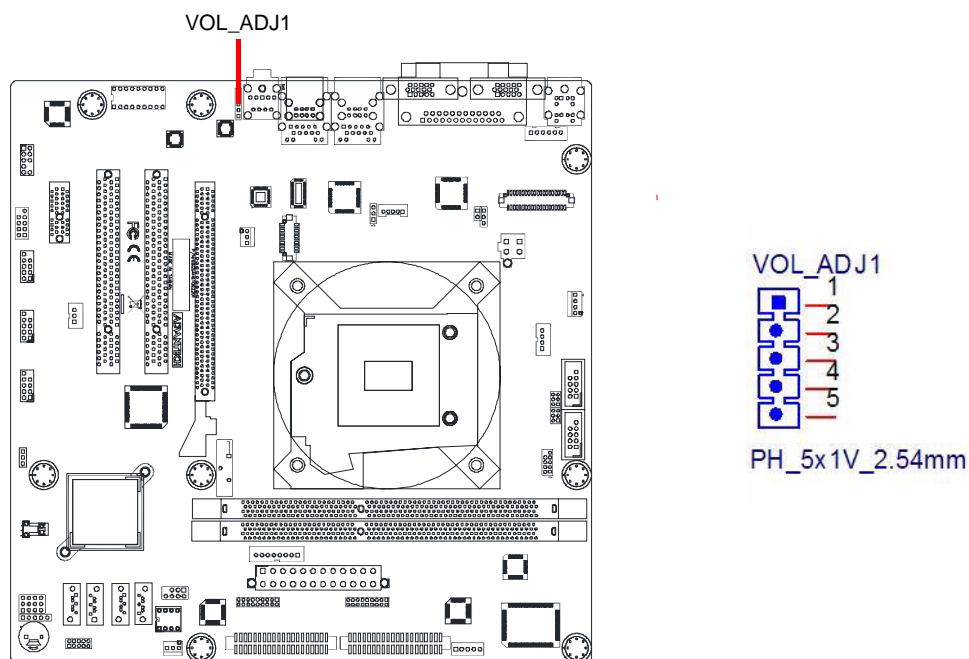

VOL_ADJ1	Adjust audio volume
Pin	Pin Name
1	AMP_L_OUT_C
2	AMP_L_OUT
3	GND
4	AMP_R_OUT
5	AMP_R_OUT_C

Function	Jumper Setting
*audio from LINE_OUT	1-2 closed, 4-5 closed

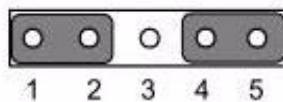

Caution! *The volume output from LINE_OUT has been amplified so please be cautious when use earphone. Jumper 1-2 & 4-5 can be removed if user need sound from LINE_OUT with a tuner.*



2.14 PCI express x16 slot

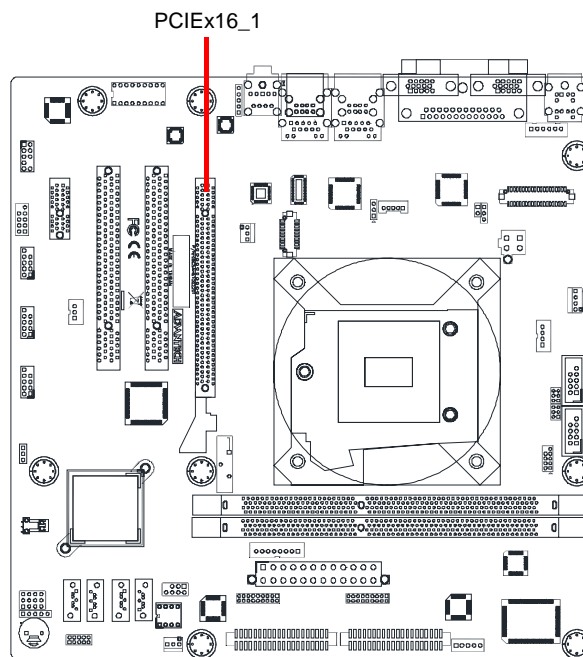

AIMB-501 provides a PCIe x16 slot for users to install add-on cards when their applications require higher graphic performance than the CPU embedded graphics controller can provide.

2.15 Front Headphone Connector (FPAUD1)

This connector is for a chassis-mounted front panel audio I/O module that supports either HD Audio or legacy AC'97 (optional) audio standard. Connect this connector with the front panel audio I/O module cable.

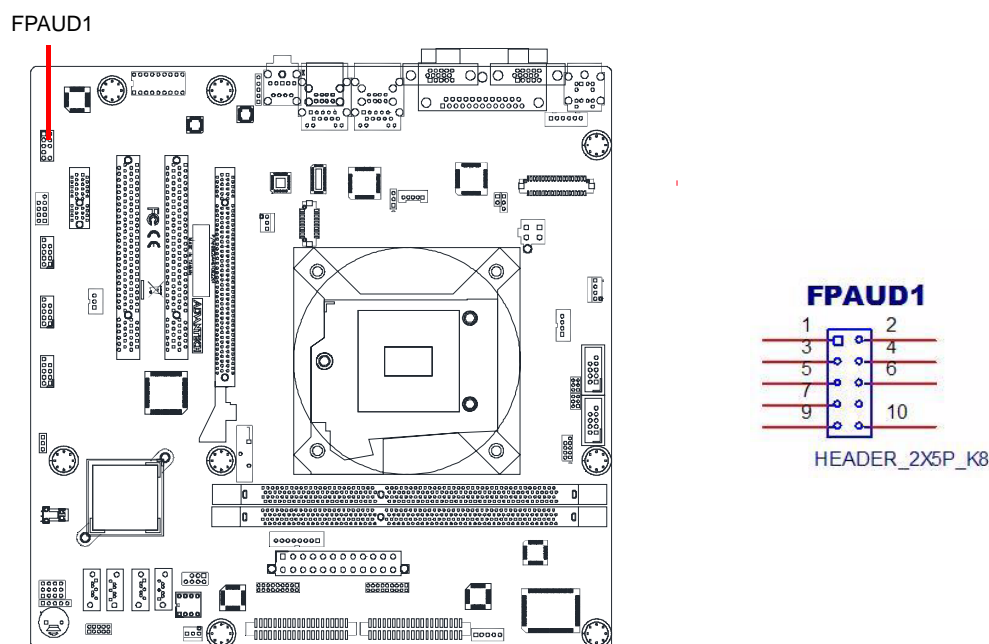

FPAUD1	Front audio header
Pin	Pin Name
1	MIC2_L
2	GND
3	MIC2_R
4	F_AUDIO_DET#
5	LIN2_R
6	MIC2_JD
7	SENSE_B
8	NC
9	LIN2_L
10	LIN2_JD

Note!  For motherboards with the optional HD Audio feature, we recommend that you connect a high-definition front panel audio module to this connector to take advantage of the motherboard's high definition audio capability.

2.16 ATX Power Connector (EATXPWR1, ATX12V1)

This connector is for an ATX Micro-Fit power supply. The plugs from the power supply are designed to fit these connectors in only one direction. Determine the proper orientation and push down firmly until the connectors mate completely.

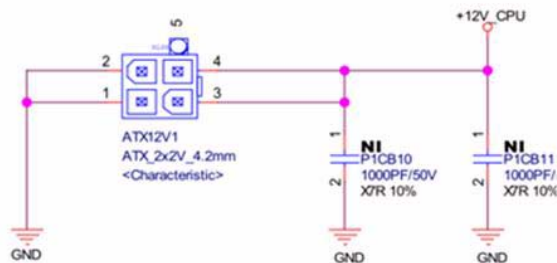
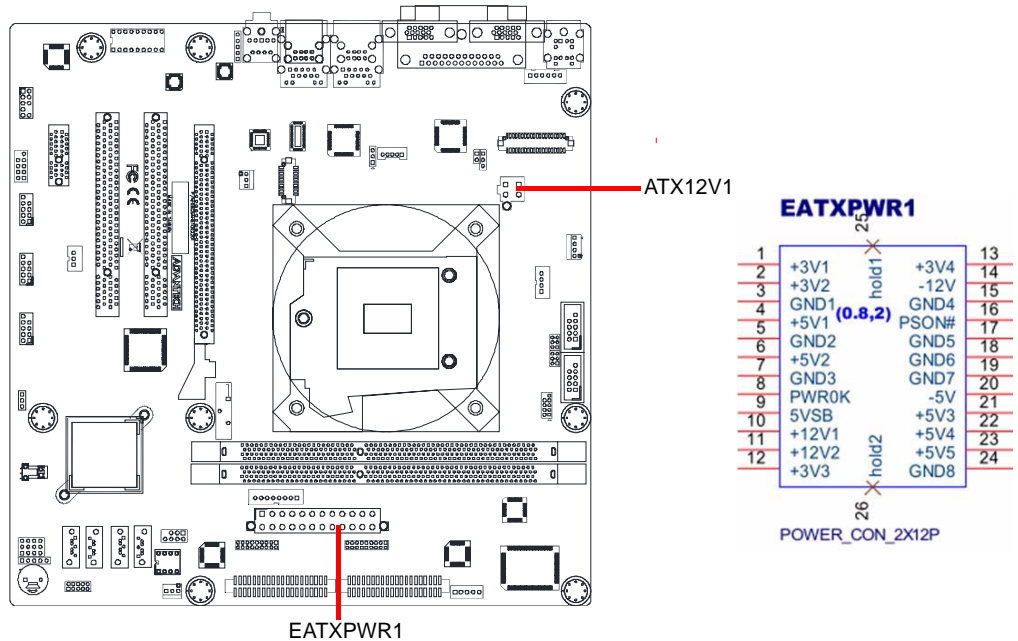

- Note!**
1. Please connect the ATX12V1 connector with the PSU ATX 12V 4-pin connector.
 2. For a fully configured system, we recommend that you use a power supply unit (PSU) that complies with ATX 12 V Specification 2.0 (or later version) and provides a minimum power of 180 W.

2.17 SPI Flash connector(SPI_CN1)

The SPI flash card pin header may be used to flash the BIOS if the AIMB-501 cannot power on.

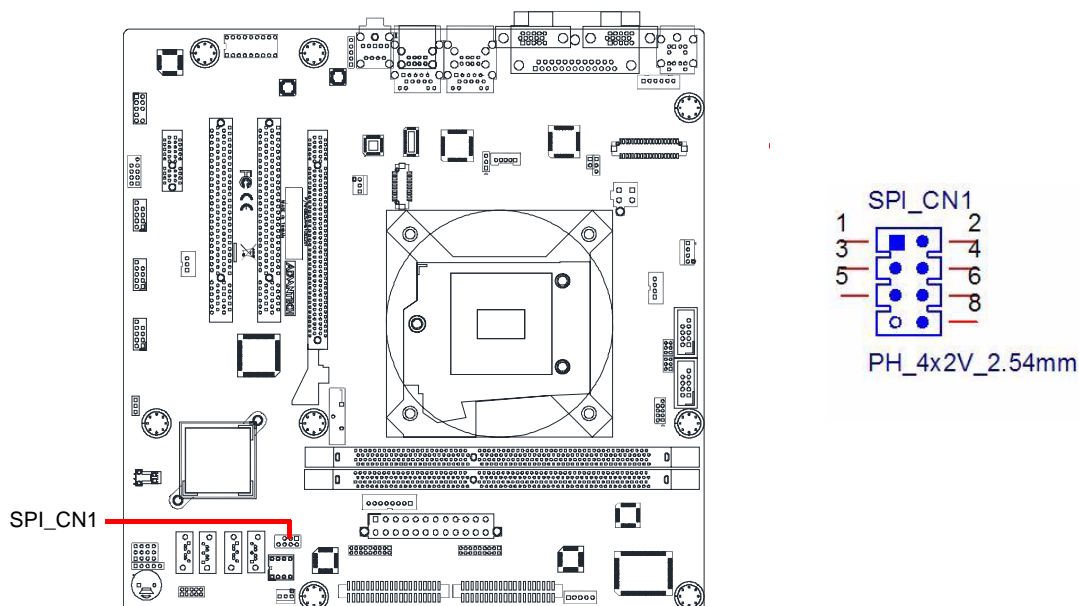

SPI_CN1	SPI connector
Pin	Pin Name
1	SPI_POWER
2	GND
3	SPI_CS#
4	SPI_CLK
5	SPI_MISO
6	SPI_MOSI
7	NC
8	SPI_HOLD#

2.18 LCD Inverter Connector (INV1)

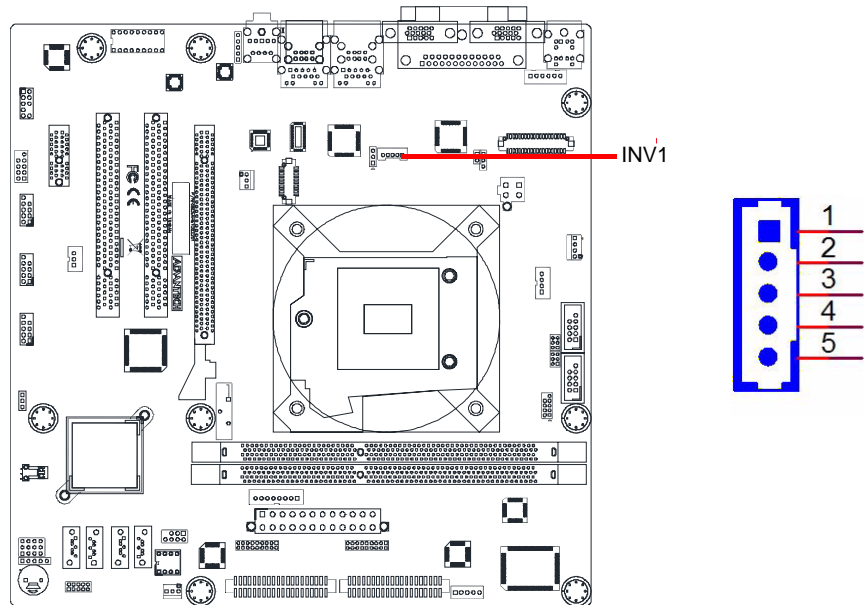

INV1	Inverter Power Output
Pin	Pin Name
1	+12V
2	GND
3	ENABKL
4	VBR
5	+5V

2.19 LVDS Connector (LVDS1)

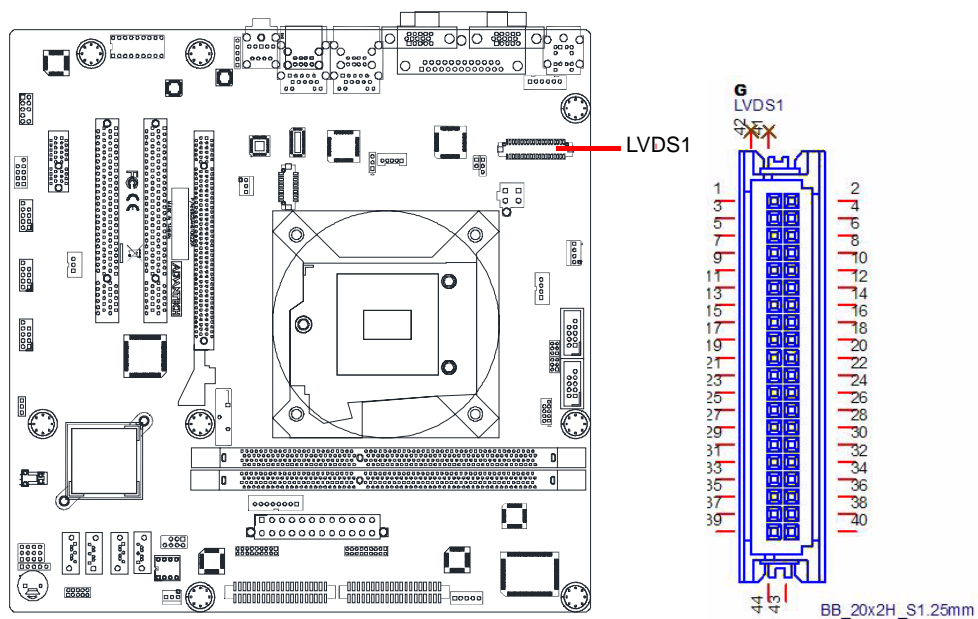

2.20 General Purpose I/O Connector (GPIO1)

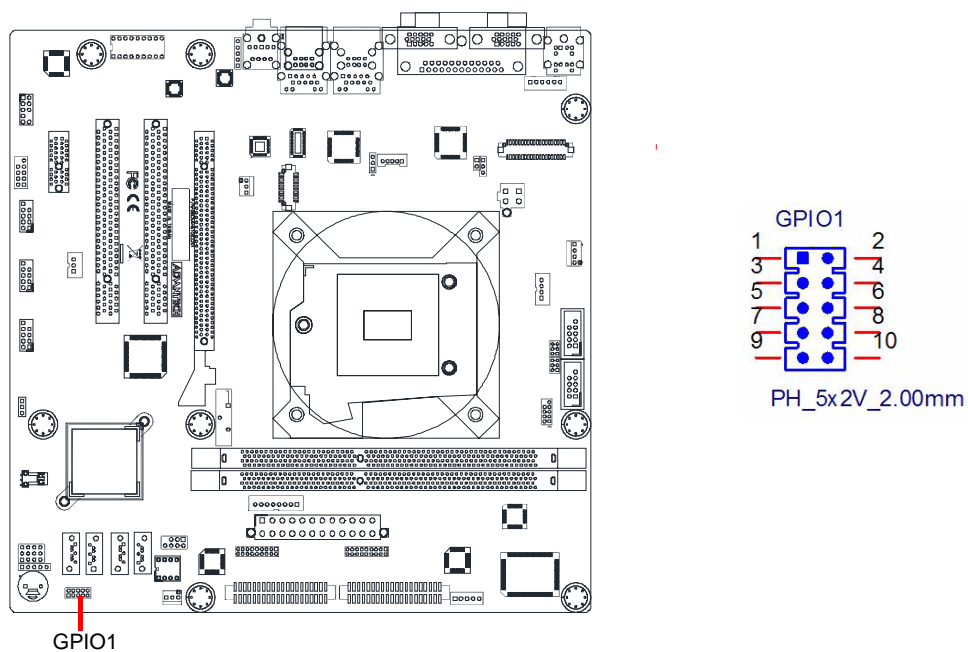

GPIO1	GPIO connector
Pin	Pin Name
1	SIO_SPI00
2	SIO_SPI01

3	SIO_SPIO2
4	SIO_SPIO3
5	SIO_SPIO4
6	SIO_SPIO5
7	SIO_SPIO6
8	SIO_SPIO7
9	VCC_GPIO
10	GND

2.21 LPC Connector for Debug (LPC1)

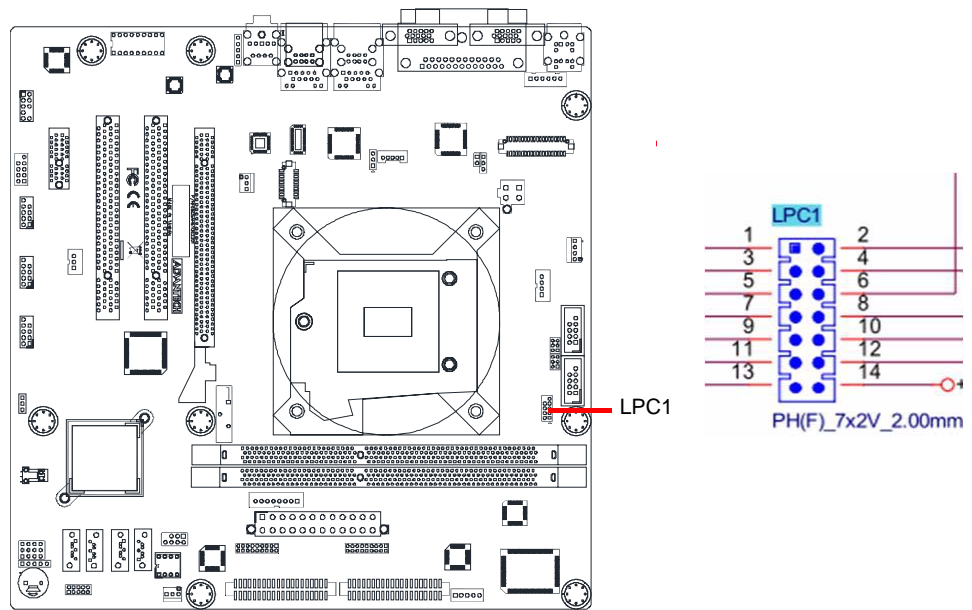

Chapter 3

BIOS Operation

3.1 Introduction

AMI BIOS has been integrated into many motherboards, and has been very popular for over a decade. People sometimes refer to the AMI BIOS setup menu as BIOS, BIOS setup or CMOS setup.

With the AMI BIOS Setup program, you can modify BIOS settings to control the special features of your computer. The Setup program uses a number of menus for making changes. This chapter describes the basic navigation of the AIMB-501 setup screens.

3.2 BIOS Setup

The AIMB-501 Series system has AMI BIOS built in, with a CMOS SETUP utility that allows users to configure required settings or to activate certain system features.

The CMOS SETUP saves the configuration in the CMOS RAM of the motherboard. When the power is turned off, the battery on the board supplies the necessary power to preserve the CMOS RAM.

When the power is turned on, press the button during the BIOS POST (Power-On Self Test) to access the CMOS SETUP screen.

Control Keys

< ↑ >> ↓ >> ← >> → >	Move to select item
----------------------	---------------------

<Enter>	Select Item
---------	-------------

<Esc>	Main Menu - Quit and not save changes into CMOS Sub Menu - Exit current page and return to Main Menu
-------	---

<Page Up/+>	Increase the numeric value or make changes
-------------	--

<Page Down/->	Decrease the numeric value or make changes
---------------	--

<F1>	General help, for Setup Sub Menu
------	----------------------------------

<F2>	Item Help
------	-----------

<F5>	Load Previous Values
------	----------------------

<F7>	Load Setup Defaults
------	---------------------

<F10>	Save all CMOS changes
-------	-----------------------

3.3 Main BIOS Setup

Press to enter AMI BIOS CMOS Setup Utility, the Main Menu will appear on the screen. Use arrow keys to select among the items and press <Enter> to accept or enter the sub-menu.

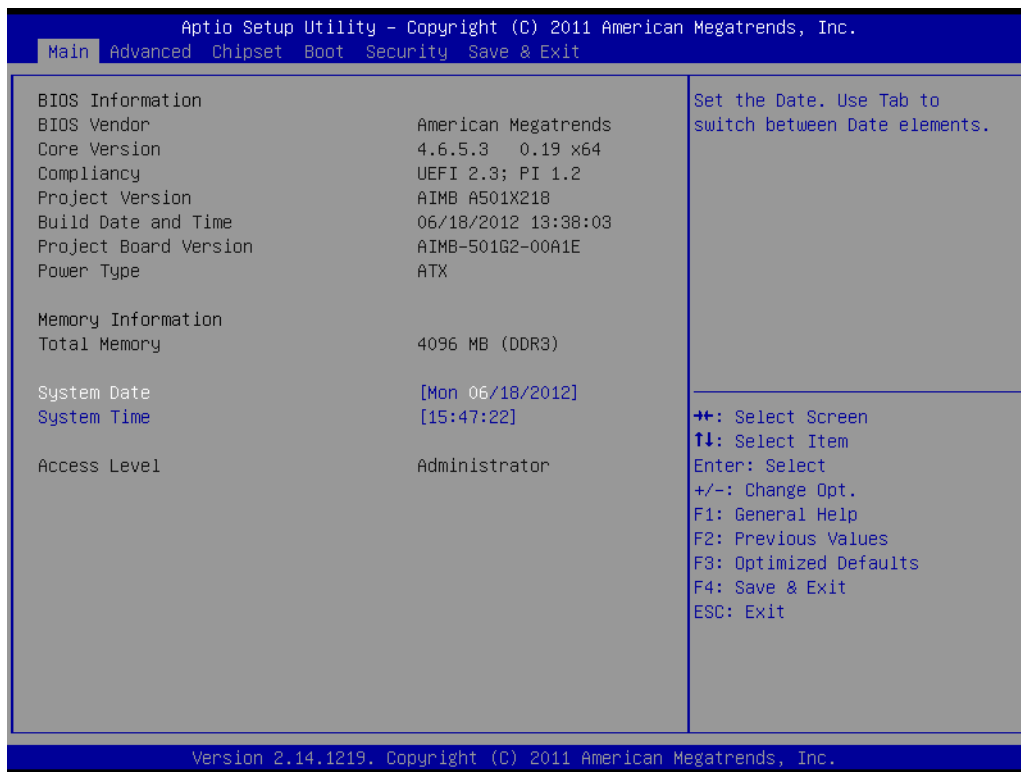

The Main BIOS setup screen has two main frames. The left frame displays all the options that can be configured. Grayed-out options cannot be configured; options in blue can. The right frame displays the key legend.

Above the key legend is an area reserved for a text message. When an option is selected in the left frame, it is highlighted in white. Often a text message will accompany it.

■ System time / System date

Use this option to change the system time and date. Highlight System Time or System Date using the <Arrow> keys. Enter new values through the keyboard. Press the <Tab> key or the <Arrow> keys to move between fields. The date must be entered in MM/DD/YY format. The time must be entered in HH:MM:SS format.

3.3.1 Advanced BIOS Features

Select the Advanced tab from the AIMB-501 setup screen to enter the Advanced BIOS Setup screen. You can select any of the items in the left frame of the screen, such as CPU Configuration, to go to the sub menu for that item. You can display an Advanced BIOS Setup option by highlighting it using the <Arrow> keys. All Advanced BIOS Setup options are described in this section. The Advanced BIOS Setup screen is shown below. The sub menus are described on the following pages.

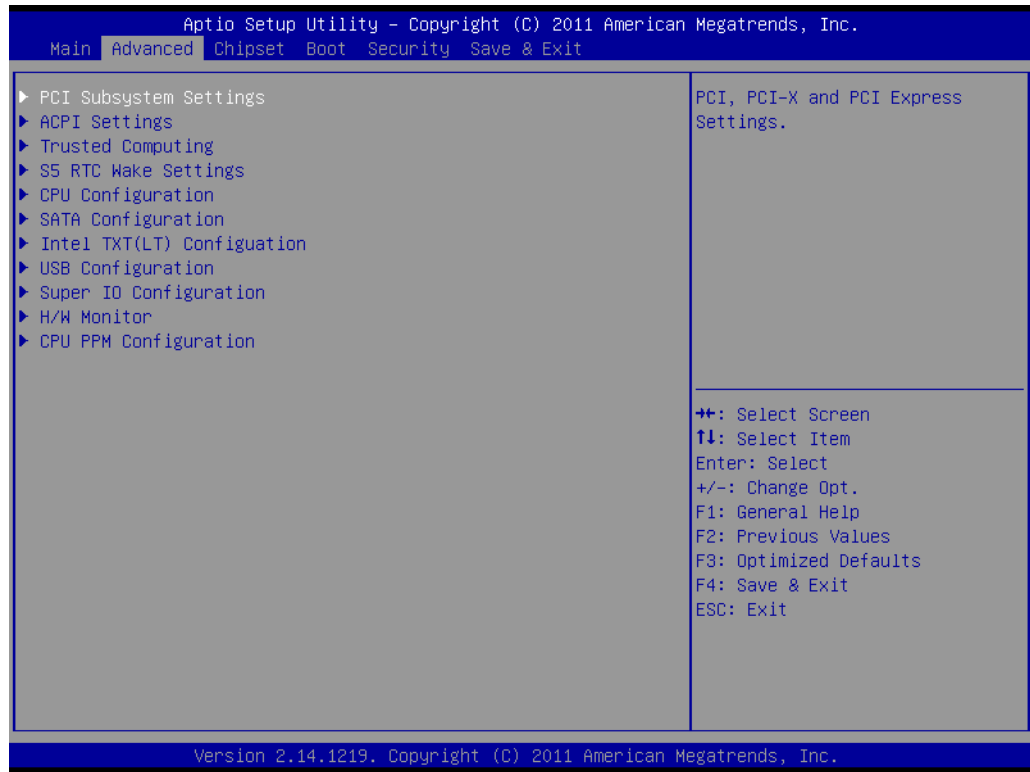

3.3.2 PCI Configuration

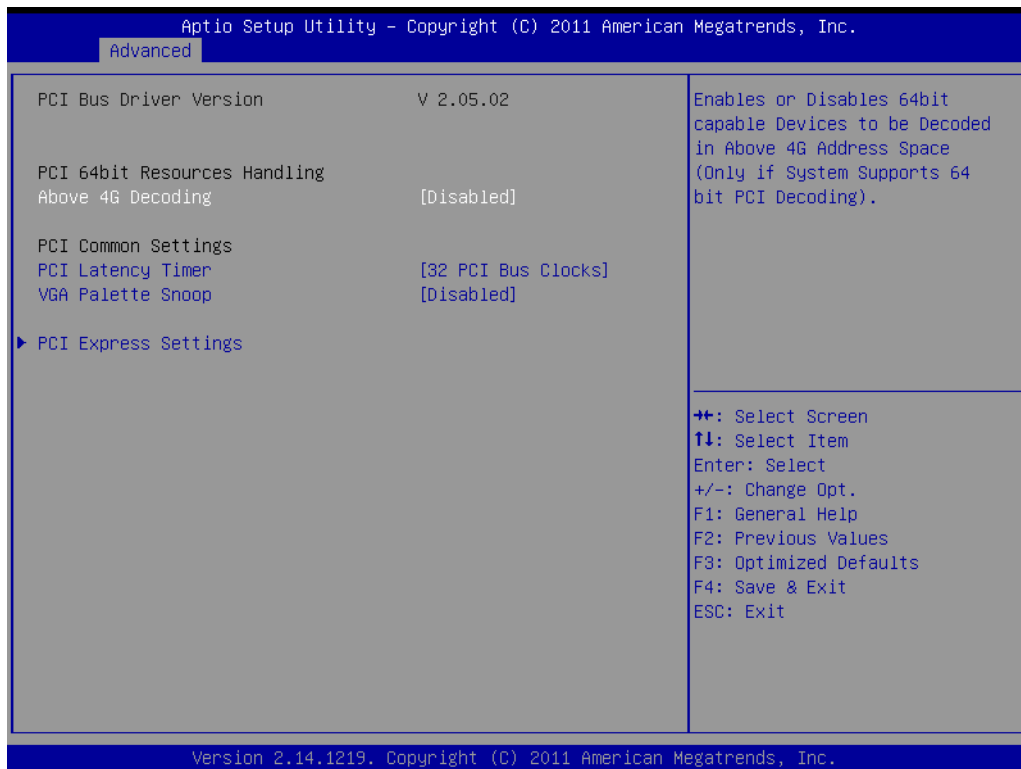

- **Above 4G Decoding**
To disabled or enabled “Above 4G Decoding”. When select enabled, it could enhance the compatibility for 64bit PCI device.
- **PCI Latency Timer**
Use this to adjust the PCI Latency Timer. This option sets the latency of all PCI devices on the PCI bus. The Optimal and Fail-Safe default setting is 32.
- **VGA Palette Snoop**
Set this value to allow the system to modify the VGA Palette Snoop settings. The Optimal and Fail-Safe default setting is "Disabled".

3.3.3 PCI Express Settings

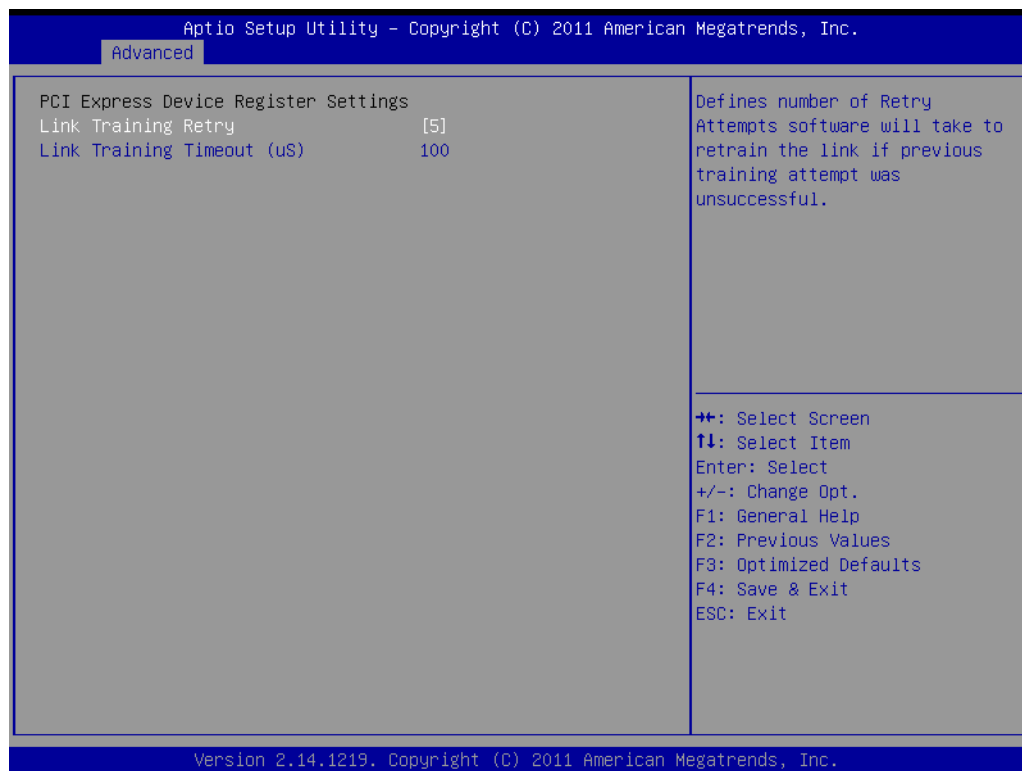

- **Link Training Retry**
To adjust the retry times when PCIE Link failure
- **Link Training Timeout**
To set up timeout for link training

3.3.4 ACPI settings

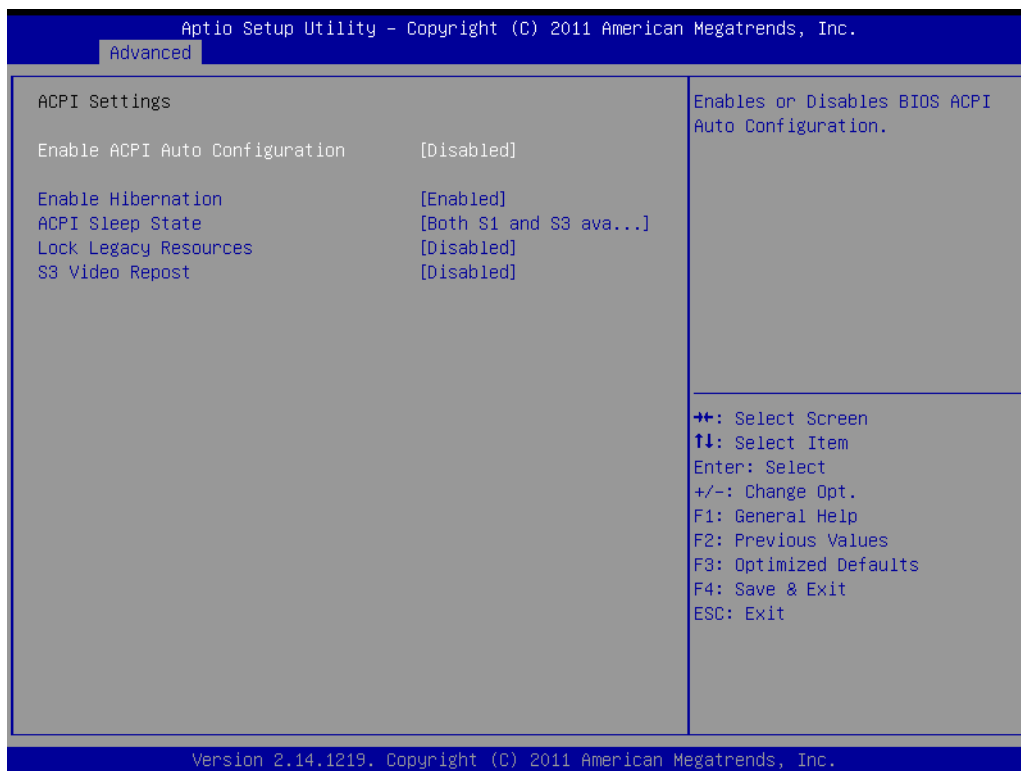

- **Enable ACPI Auto Configuration**
Enable or disable BIOS ACPI auto configuration.
- **Enable Hibernation**
This item allows users to enable or disable Hibernation.
- **ACPI Sleep State**
This item allows users to set the ACPI sleep state
- **Lock Legacy Resources**
This item allows users to lock legacy devices' resources.
- **S3 Video Repost**
Enable or disable video repost.

3.3.5 Trusted Computing

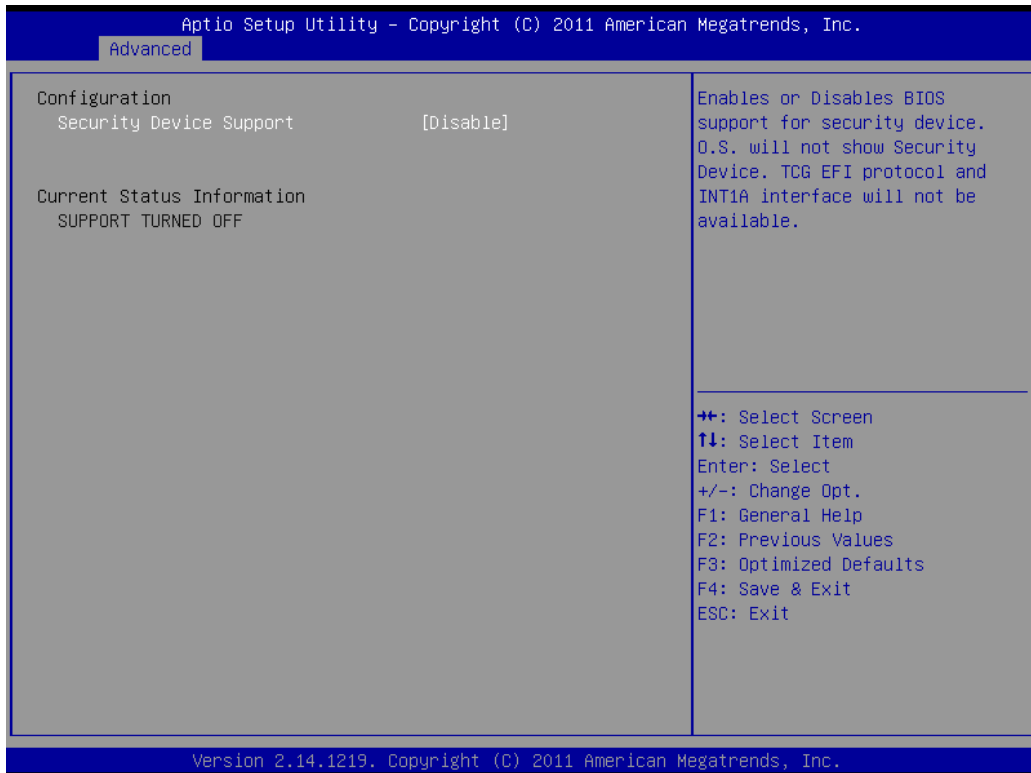

- **Security Device Support**
Enable or disable BIOS support for security device.

3.3.6 S5 RTC wake Settings



- **Wake system with fixed time**
Enable or disable system wake on alarm event.

3.3.7 SATA Configuration

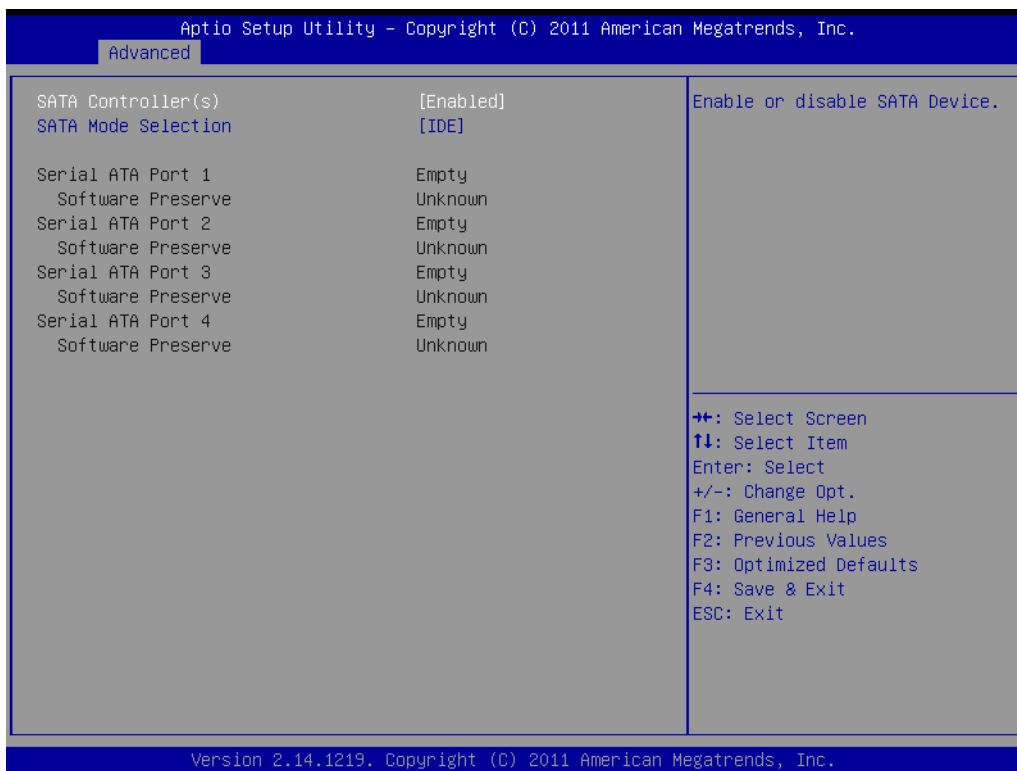

- **SATA Controllers**
To enable or disable SATA controller.
- **SATA Mode Selection**
This can be configured as IDE or AHCI mode.

3.3.8 Intel Trusted Execution Technology Configuration

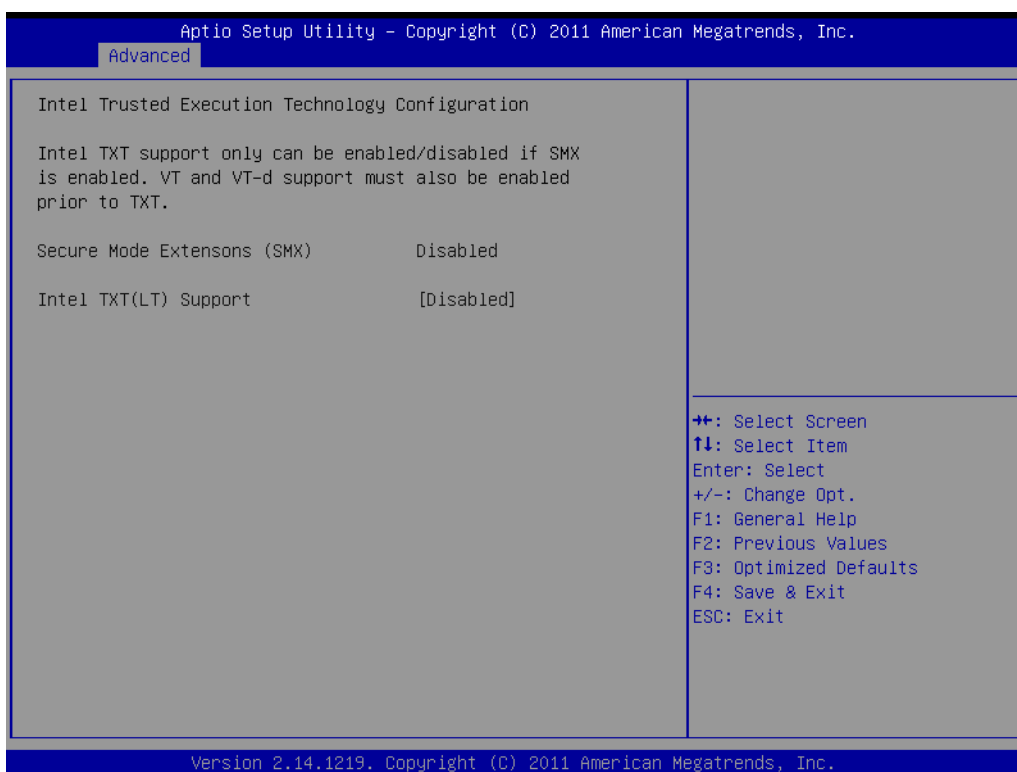

- **Secure Mode Extension (SMX)**
This item allows users to enable or disable SMX.
- **Intel TXT Configuration**
This item allow users to enable or disable Intel Trusted Execution Technology.

3.3.9 USB Configuration

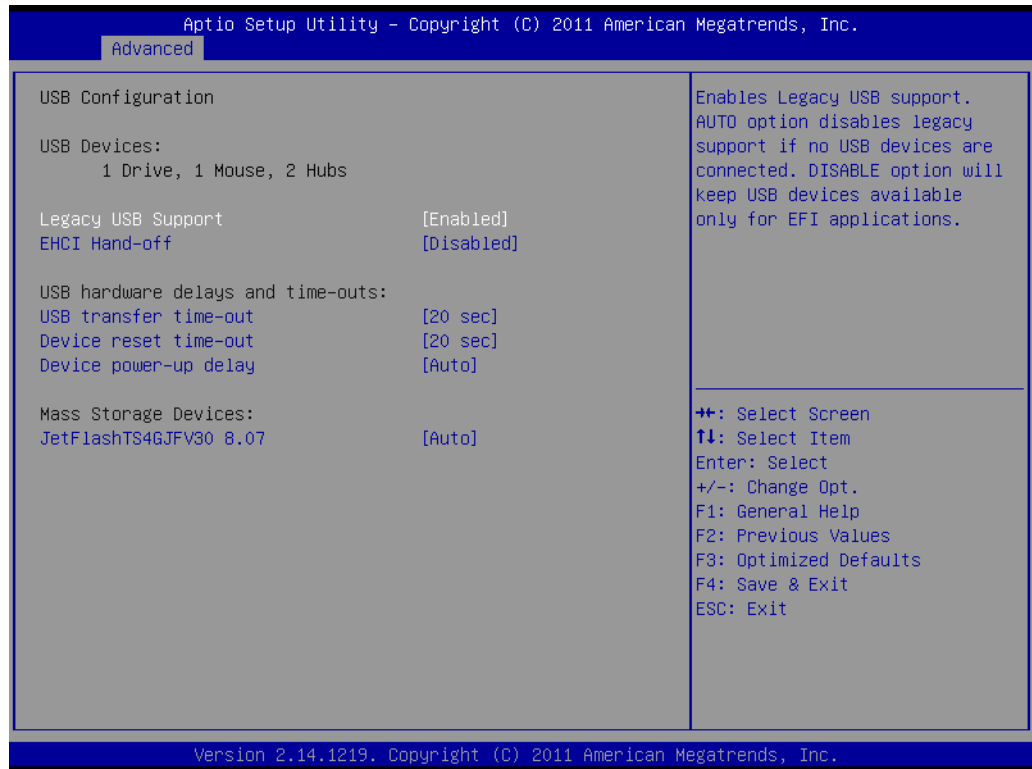

- **Legacy USB Support**
Enables support for legacy USB. Auto option disables legacy support if no USB devices are connected.
- **EHCI Hand-off**
This is just a workaround item under OS without EHCI hand-off support.
- **USB hardware delays and time-outs**
To set up parameter for detect USB device.
- **Mass Storage Devices**
Shows USB mass storage device information.

3.3.10 Super IO Configuration

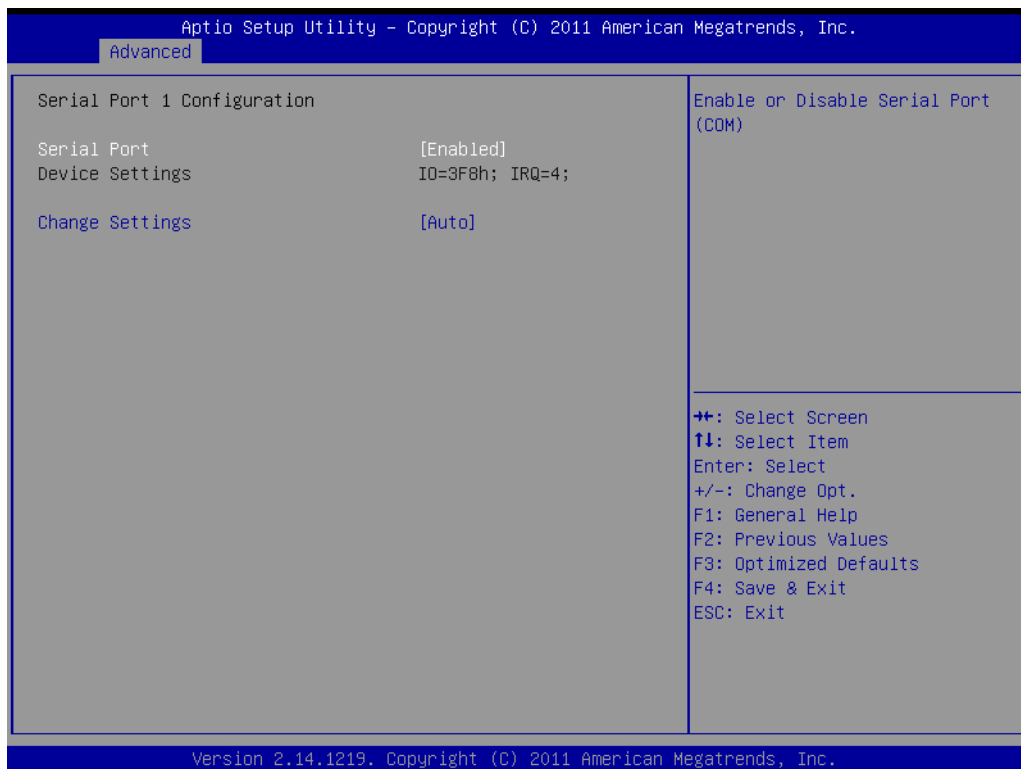
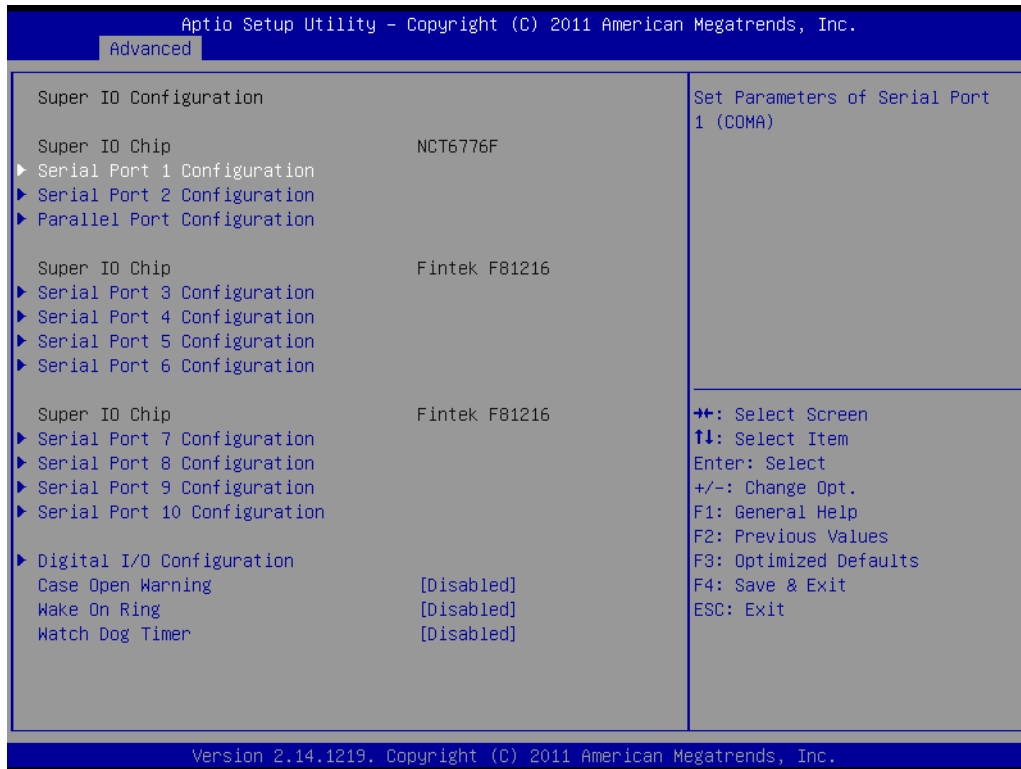

Serial Port 1 Configuration

- **Serial Port**
To “enable” or “disable” Serial Port 1.
- **Change Settings**
To select the IO address/IRQ setting for serial port 1.

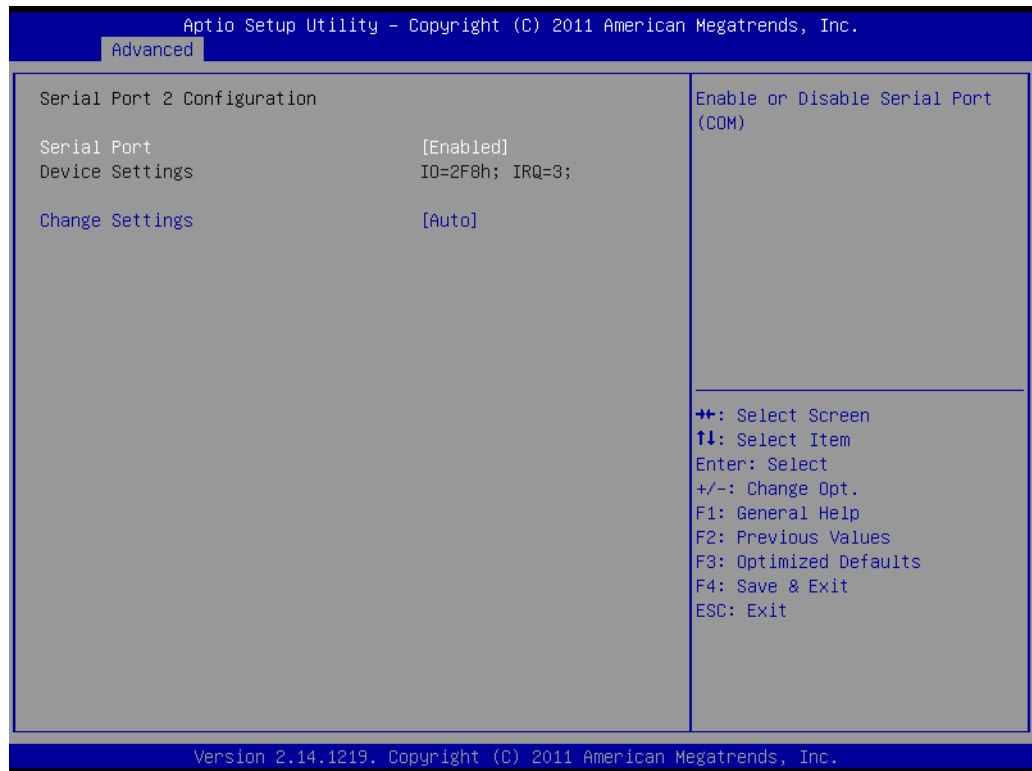

Serial Port 2 Configuration

- **Serial Port**
To “enable” or “disable” Serial Port 2.
- **Change Settings**
To select the IO address/IRQ setting for serial port 2.

Parallel Port Configuration

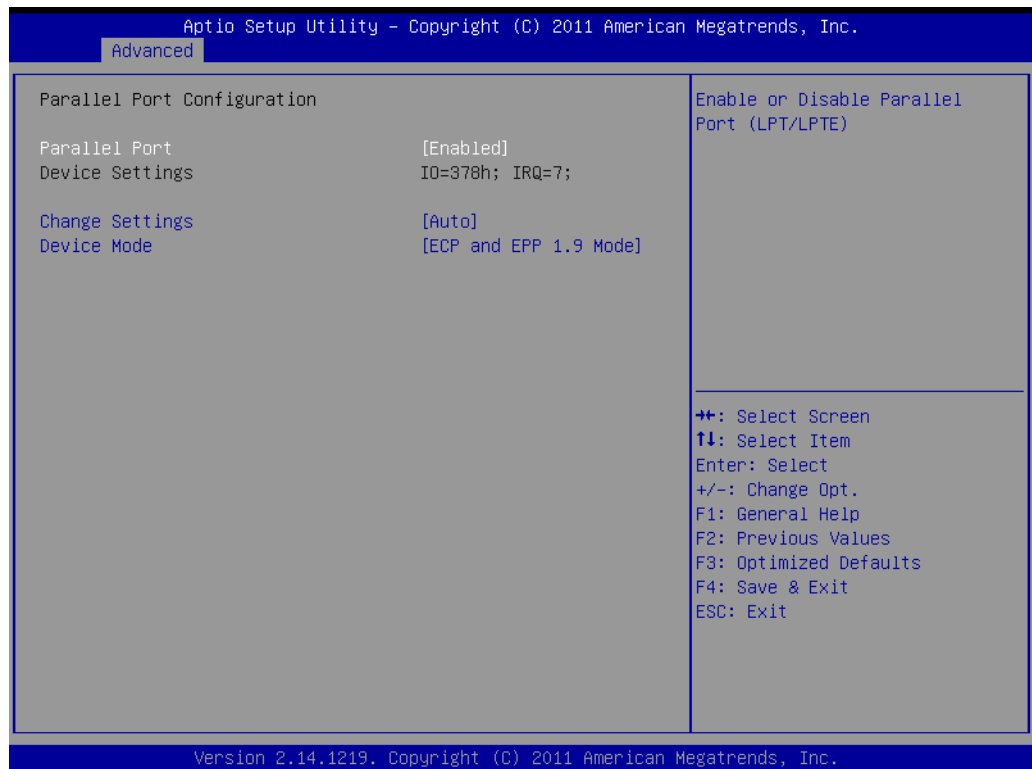

- **Parallel Port**
To enable or disable Parallel Port.

Super IO Configuration

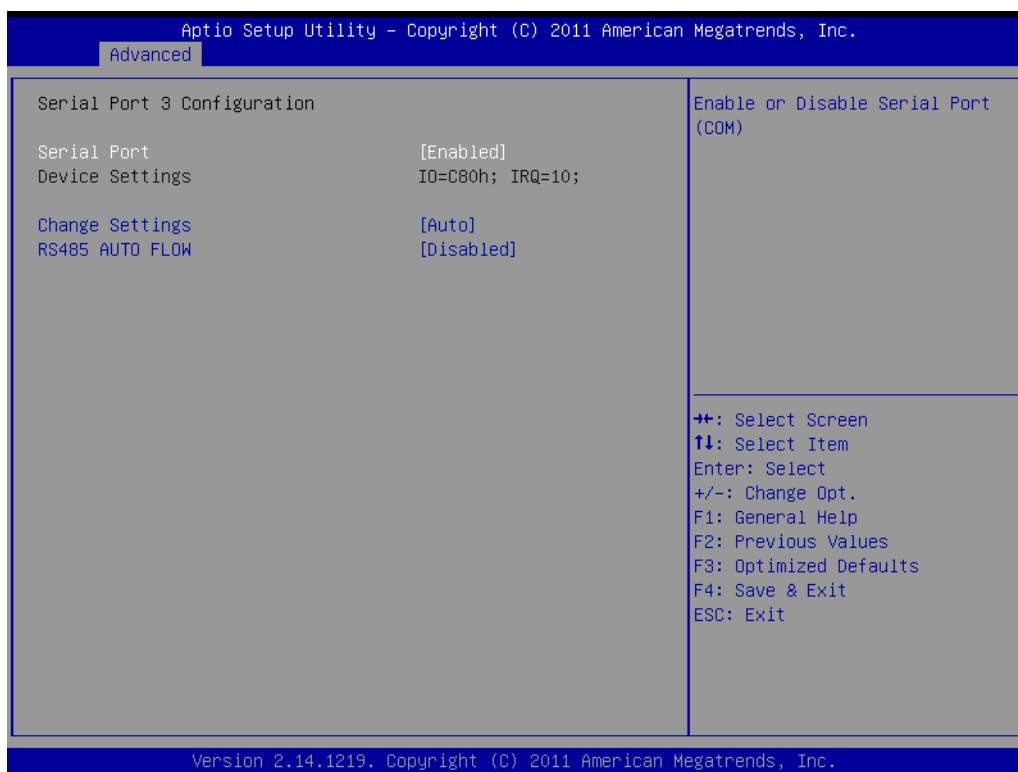

Serial Port 3 Configuration

- **Serial Port**
To “enable” or “disable” Serial Port 3.
- **Change Settings**
To select the IO address/IRQ setting for serial port 3.
- **Auto flow control**
When the COM is to set as RS-485, it supports auto flow control function.

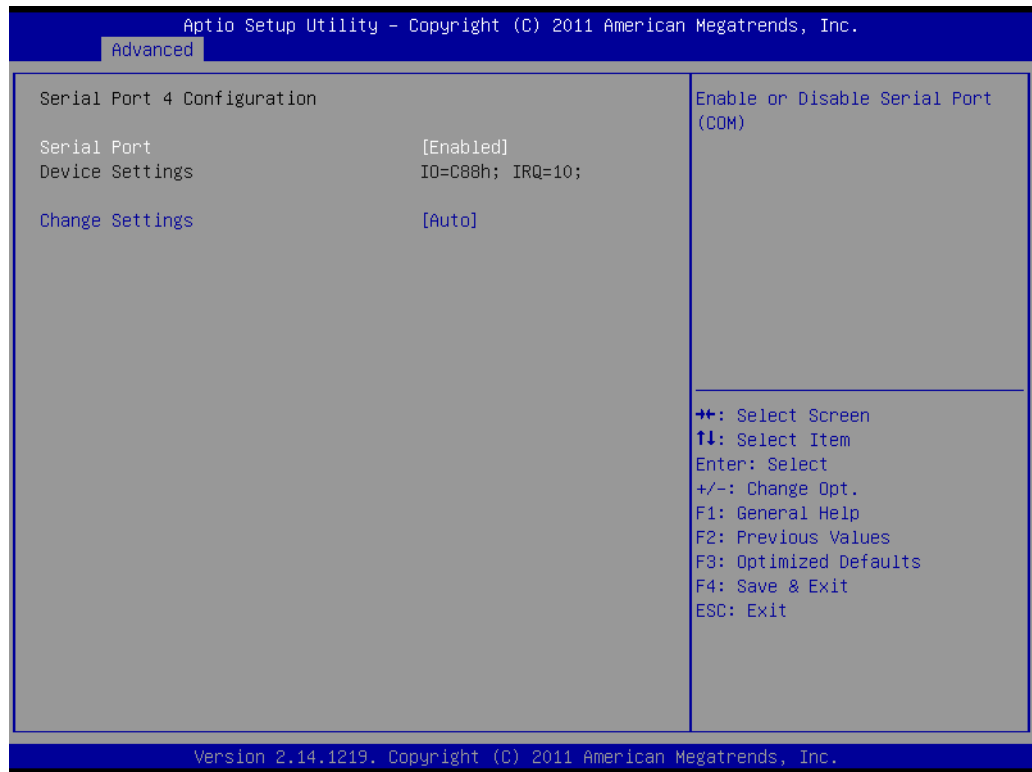

Serial Port 4 Configuration

- **Serial Port**
To “enable” or “disable” Serial Port 4.
- **Change Settings**
To select the IO address/IRQ setting for serial port 4.



Serial Port 5 Configuration

- **Serial Port**
To ,”enable” or “disable” Serial Port 5.
- **Change Settings**
To select the IO address/IRQ setting for serial port 5.



Serial Port 6 Configuration

- **Serial Port**
To “enable” or “disable” Serial Port 6.
- **Change Settings**
To select the IO address/IRQ setting for serial port 6.

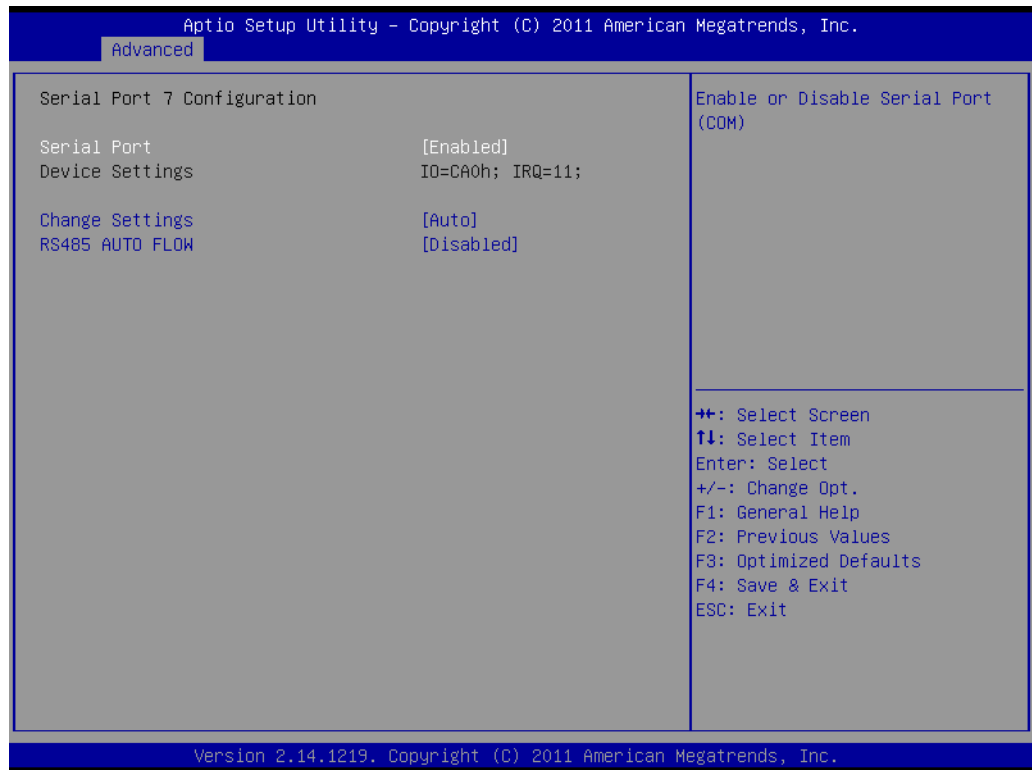

Serial Port 7 Configuration

- **Serial Port**
To “enable” or “disable” Serial Port 7.
- **Change Settings**
To select the IO address/IRQ setting for serial port 7.
- **Auto flow control**
When the COM is to set as RS-485, it supports auto flow control function.

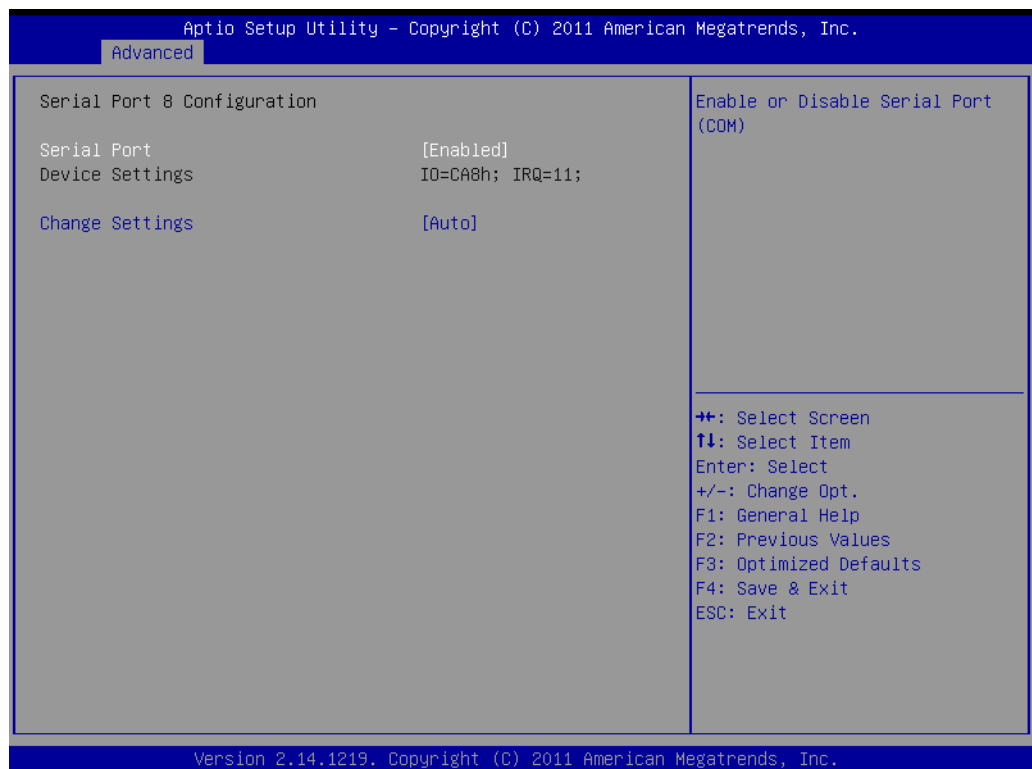

Serial Port 8 Configuration

- **Serial Port**
To “enable” or “disable” Serial Port 8.
- **Change Settings**
To select the IO address/IRQ setting for serial port 8.

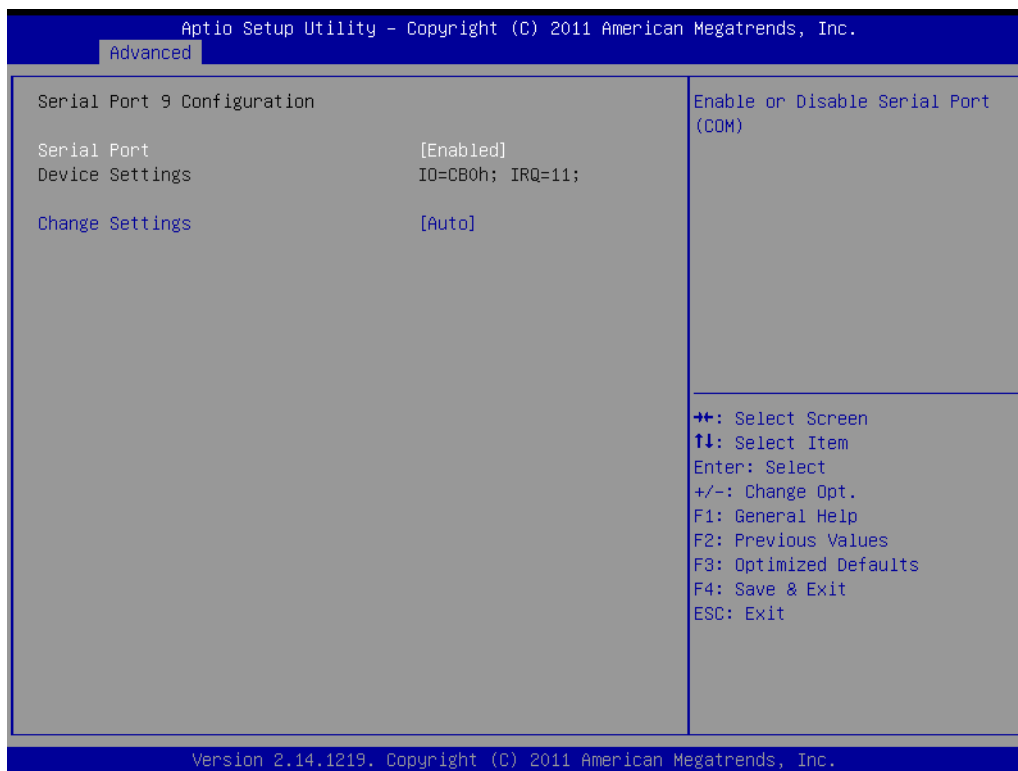

Serial Port 9 Configuration

- **Serial Port**
To “enable” or “disable” Serial Port 9.
- **Change Settings**
To select the IO address/IRQ setting for serial port 9.

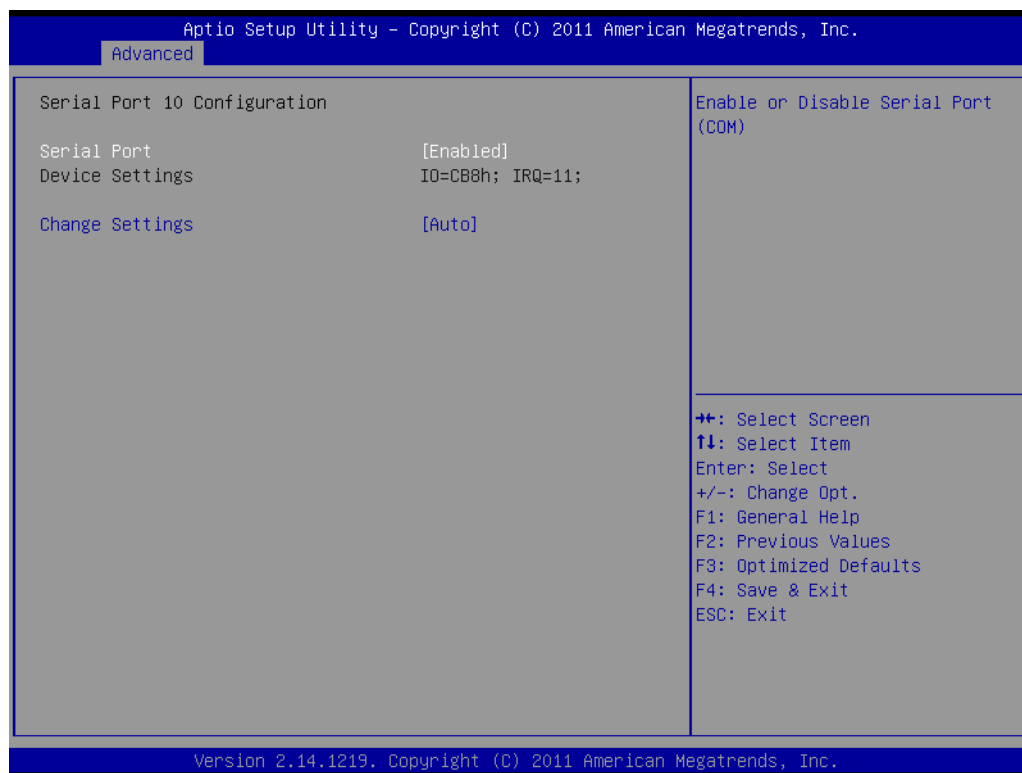

Serial Port 10 Configuration

- **Serial Port**
To “enable” or “disable” Serial Port 10.
- **Change Settings**
To select the IO address/IRQ setting for serial port 10.

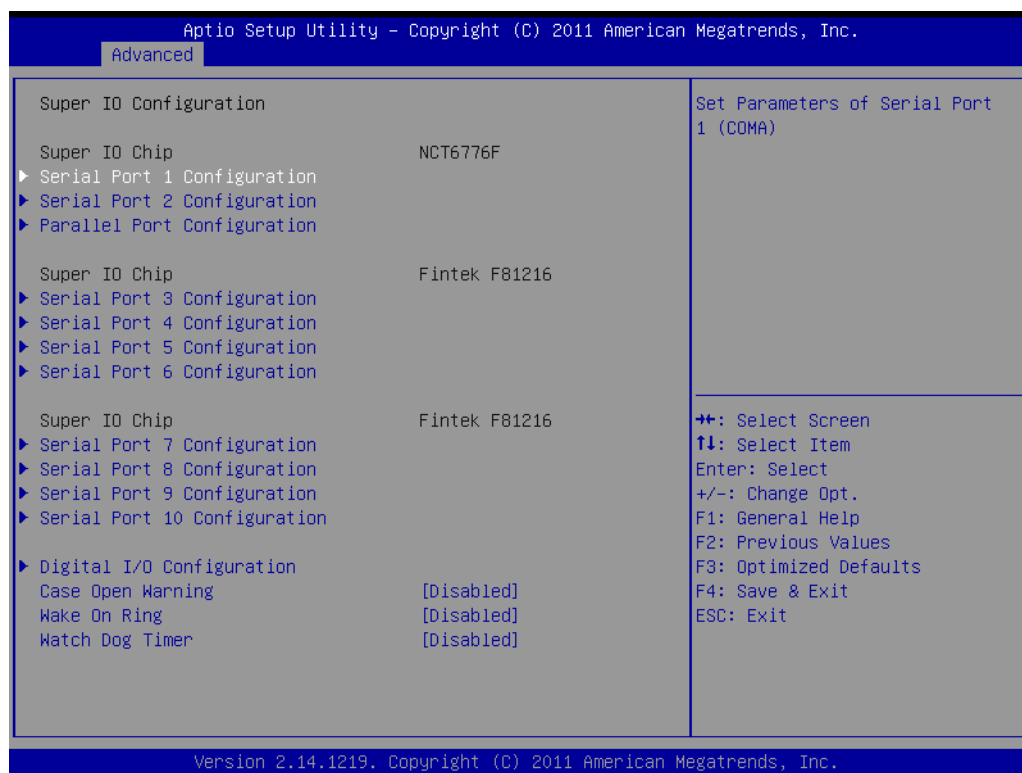

- **Digital I/O Configuration**
To configure Digital I/O

- **Case Open Warning**
To "enable" or "disable" Case Open Warning
- **Wake on Ring**
To "enable" or "disable" Wake on Ring
- **Watch Dog Timer**
To "enable" or "disable" Watch Dog Timer



- **Digital I/O Configuration**
To set up Digital I/O 1~8 to "input" or "output".

3.3.11 Smart Fan Configuration



- **CPU Smart Fan**
To enable or disable CPU smart fan.
- **System Smart Fan**
To enable or disable System Smart Fan.

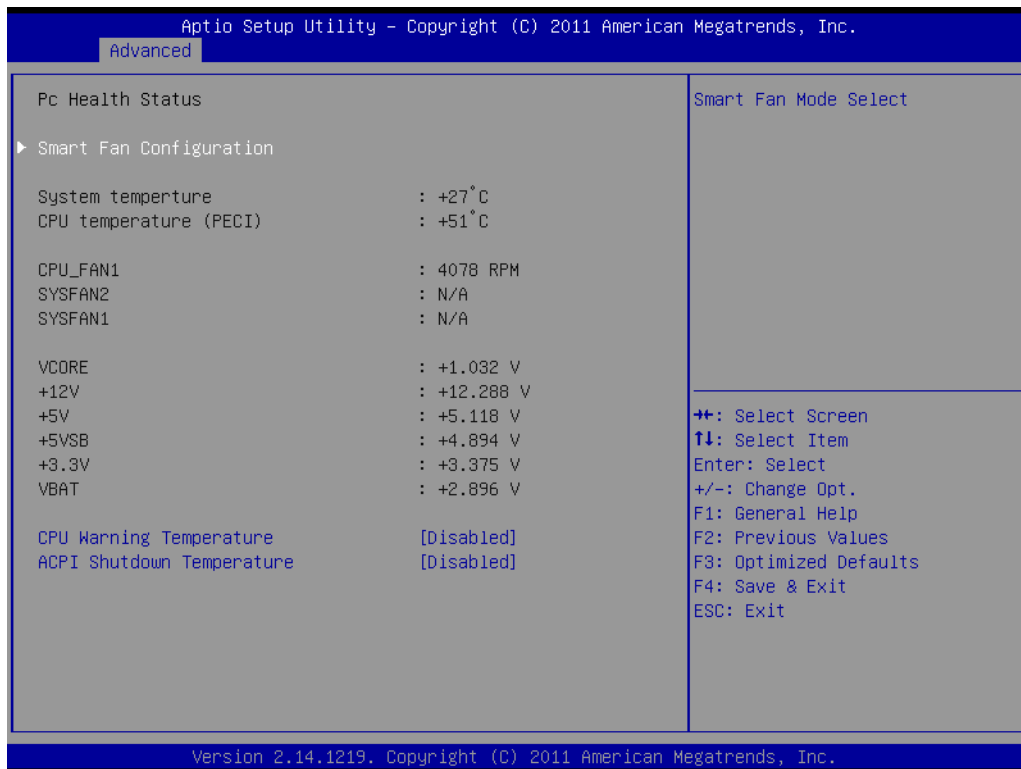

- **CPU Warning Temperature**
Use this to set the CPU warning temperature threshold. When the system CPU reaches the warning temperature, the buzzer will beep.
- **ACPI Shutdown Temperature**
This screen allows users to set the CPU temperature at which the system will automatically shut down to prevent the CPU from overheating damage.

3.3.12 CPU PPM Configuration

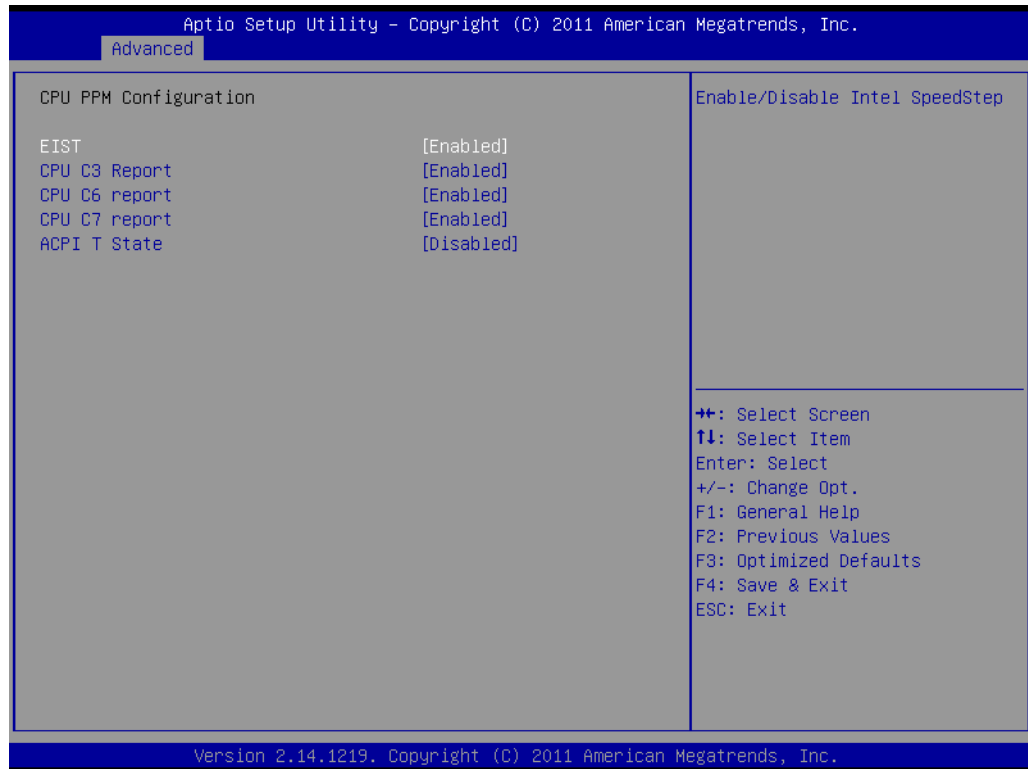

- **EIST**
CPU runs at its default speed if disabled; CPU speed is controlled by the operating system if enabled.
- **CPU C3/C6/C7 Report**
This item allows users to enable or disable CPU C-state support.
- **ACPI T state**
This item allows users to enable or disable ACPI T state function.

3.4 Chipset Configuration Setting

Select the chipset tab from the BIOS setup screen to enter the Chipset Setup screen. Users can select any item in the left frame of the screen, such as PCI express Configuration, to go to the sub menu for that item. Users can display a Chipset Setup option by highlighting it using the <Arrow> keys. All Chipset Setup options are described in this section. The Chipset Setup screens are shown below. The sub menus are described on the following pages.

3.4.1 PCH-IO Configuration

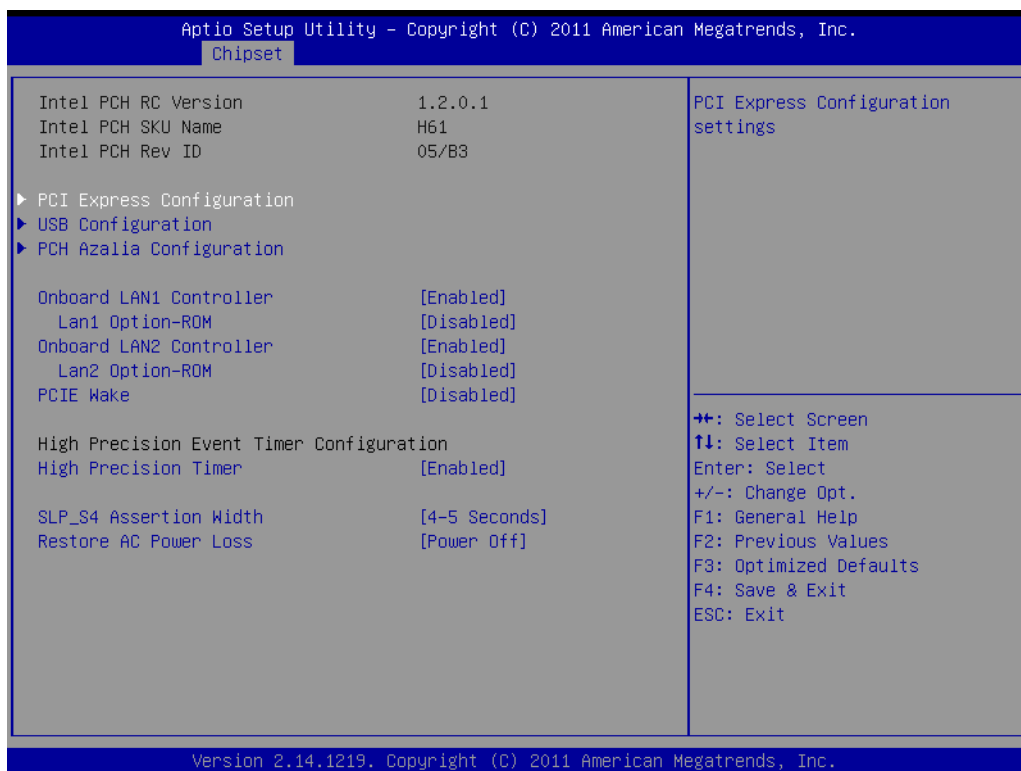

- **PCI Express Configuration**
Detail of PCI Express items.
- **USB Configuration**
Details of USB items.
- **PCH Azalia Configuration**
Details of PCH azalia items.

- **LAN controller**
Enables or disables the LAN1/2 controller.
- **LAN option-ROM**
Enables or disables the LAN1/2 option-ROM.
- **PCIE Wake**
Enables or disables PCIE device wake up from sleep state.
- **High Precision Timer**
Enables or disables the high precision timer.
- **SLP_S4 Assertion Width**
This item allows users to set a delay of sorts.
- **Restore AC Power Loss**
This item allows users to select off, on and last state.

3.4.1.1 PCI Express Configuration

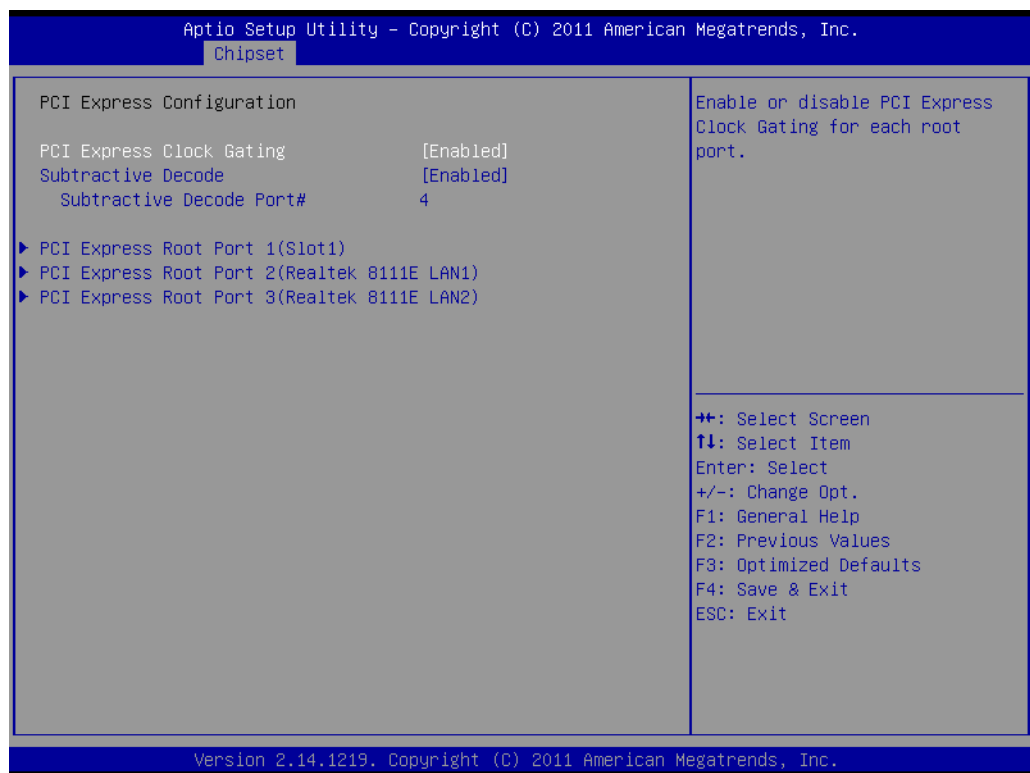

- **PCI Express Clock Gating**
Enable or disable PCI express clock gating.
- **Subtractive Decode**
Enable or disable Subtractive decode.

3.4.1.2 PCI Express Root Port 1/2/3

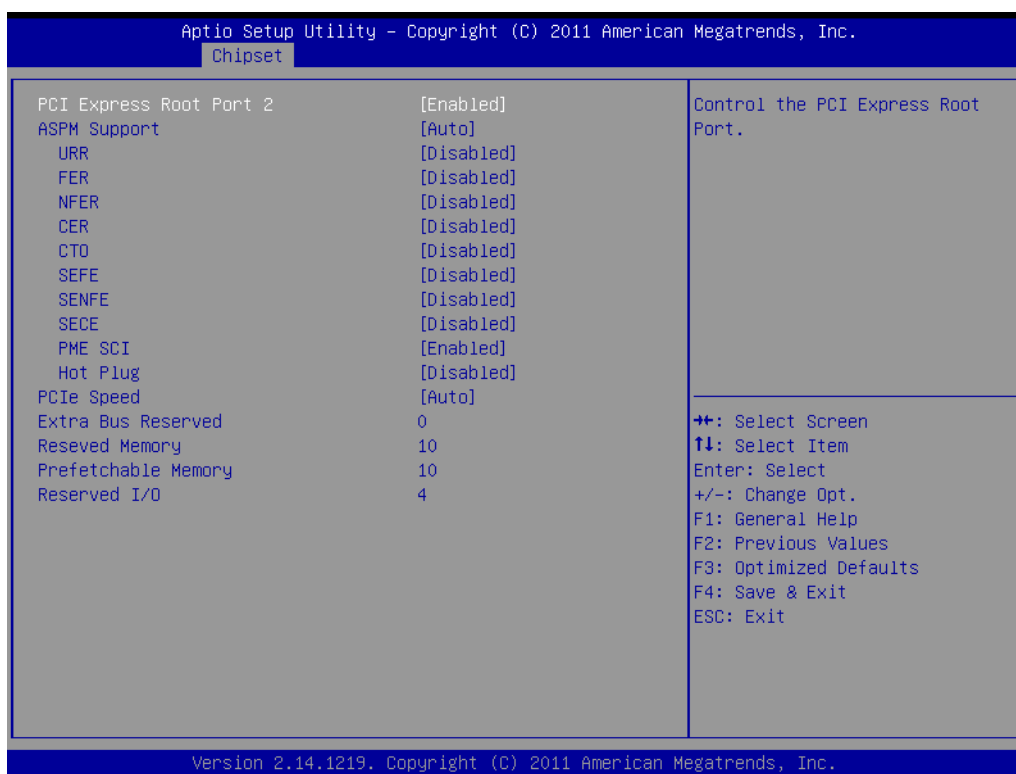
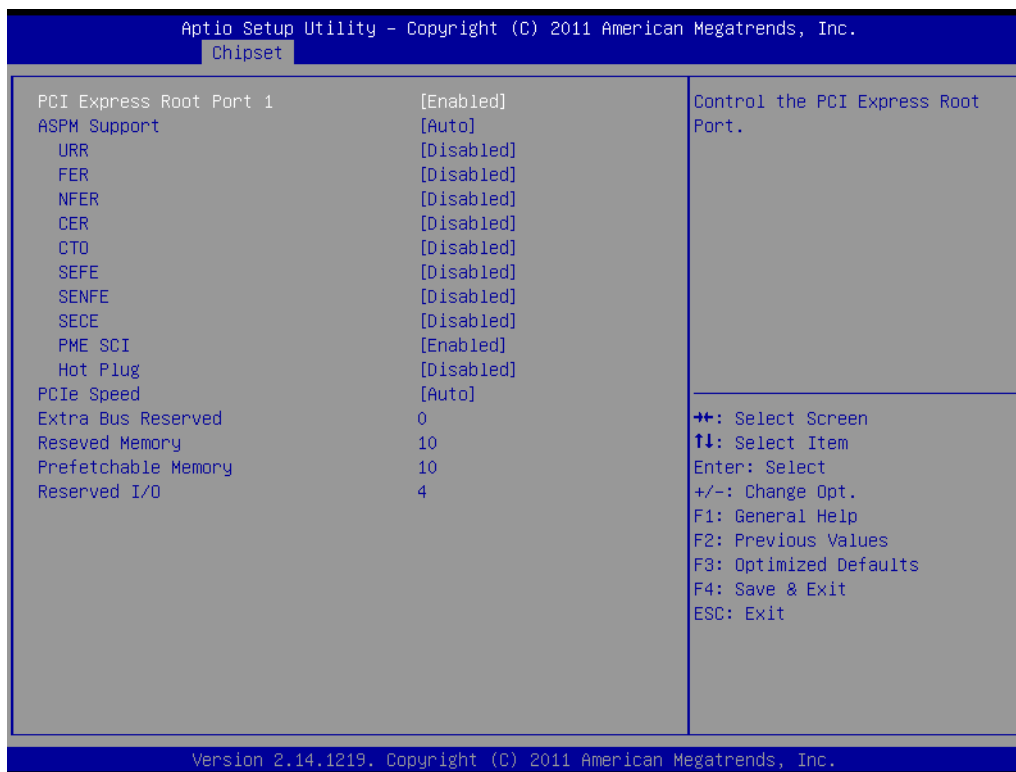

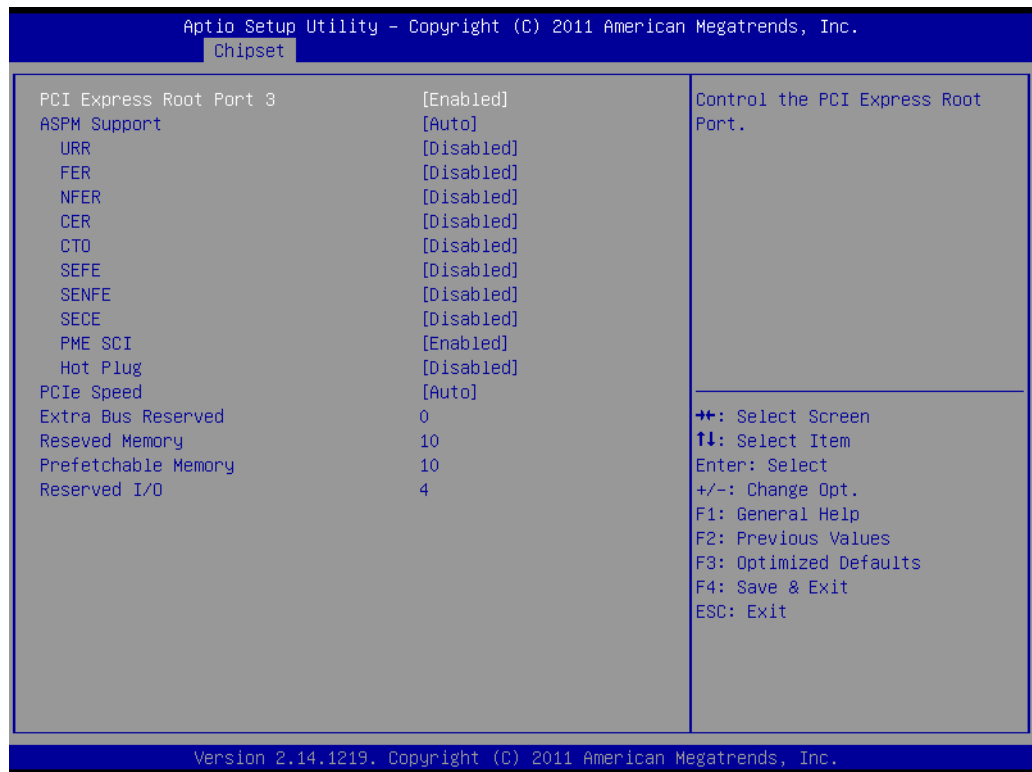

This pages allow users to adjust parameter for PCI express root port 1&2&3.

- **ASPM Support**
Allow user to set the ASPM Level. Force L0s - Force all links to L0s State. AUTO - BIOS auto configure. DISABLE - Disables ASPM.
- **URR**
Enable or disable PCI Express Unsupported Request Reporting.
- **FER**
Enable or disable PCI Express Device Fatal Error Reporting.
- **NFER**
Enable or disable PCI Express Device Non-Fatal Error Reporting.
- **CER**
Enable or disable PCI Express Device Correctable Error Reporting.
- **CTO**
Enable or disable PCI Express Completion Timer TO.
- **SEFE**
Enable or disable Root PCI Express System Error on Fatal Error.
- **SENF**
Enable or disable Root PCI Express System Error on Non-Fatal Error.
- **SECE**
Enable or disable Root PCI Express System Error on Correctable Error.
- **PME SCI**
Enable or disable PCI Express PME SCI.
- **Hot Plug**
Enable or disable PCI Express Hot Plug.
- **PCIe Speed**
Select PCI Express port speed.
- **Extra Bus Reserved**

Extra Bus Reserved for bridges behind this Root Bridge.

- **Reserved Memory**
Reserved Memory Range for this Root Bridge.
- **Prefetchable Memory**
Prefetchable Memory Range for this Root Bridge.
- **Reserved I/O**
Reserved I/O (4K/8K/12K/16K/20K) Range for this Root Bridge

3.4.2 USB Configuration

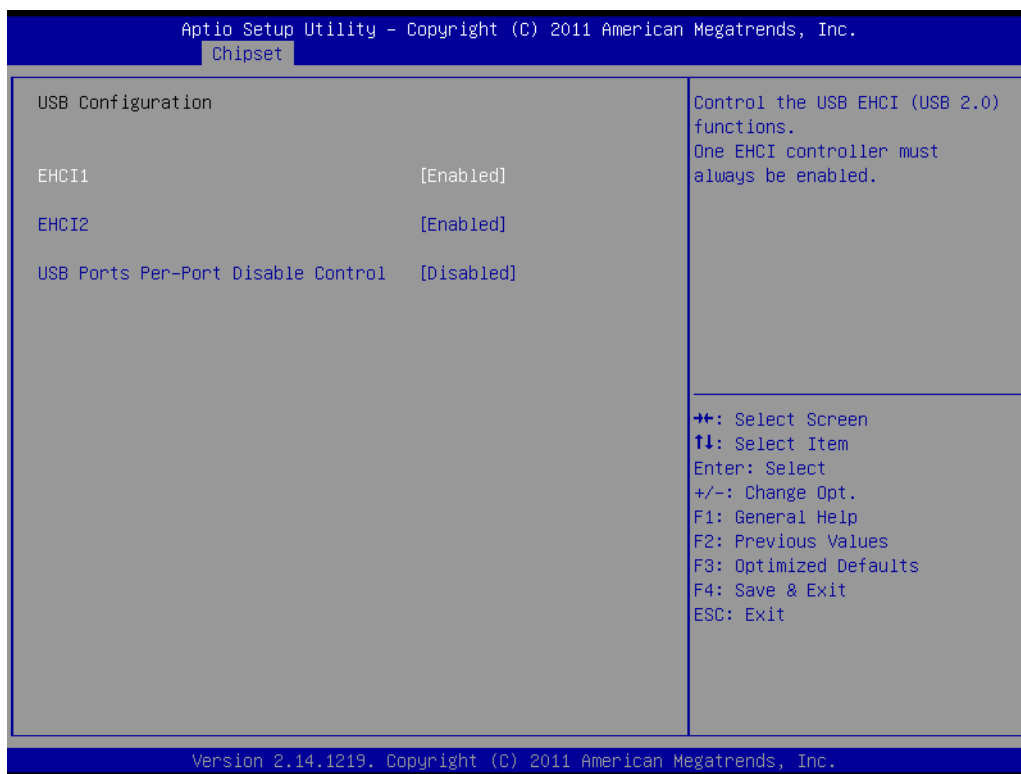

- **EHCI 1/2**
Enables or disables the EHCI controller.
- **USB Ports pre-port Disable Control**
This item allows users to enable or disable each USB port individually.

3.4.3 PCH Azalia Configuration

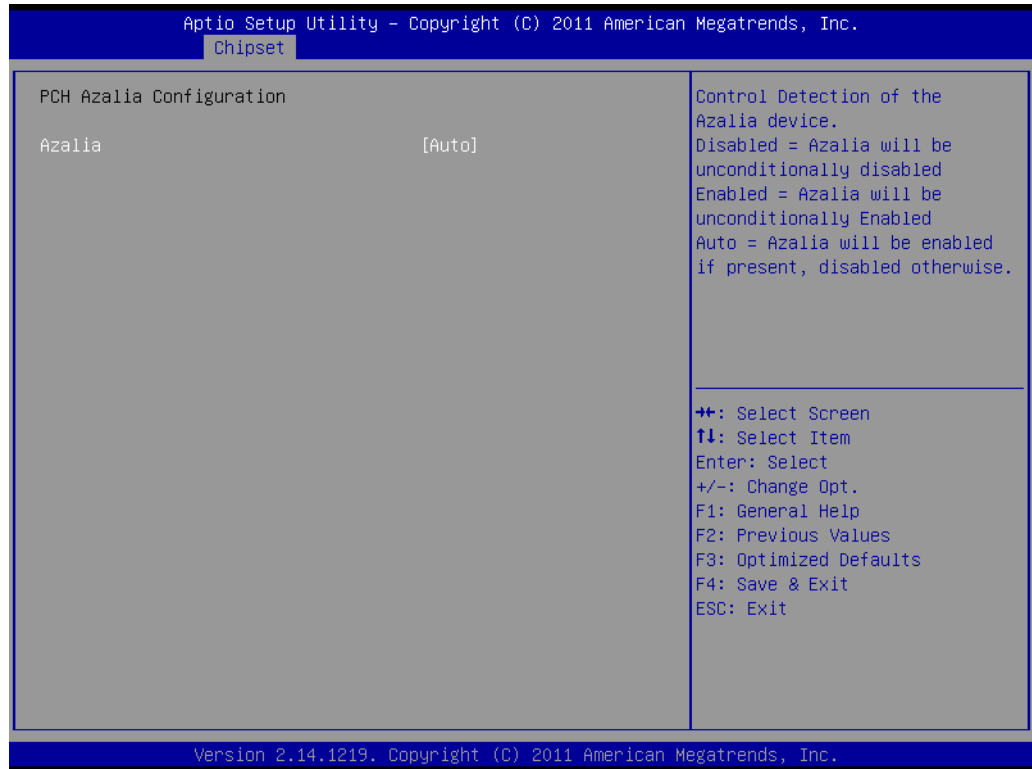

- **Azalia**
This item allows user to enable or disable azalea device.

3.4.4 System agent Configuration

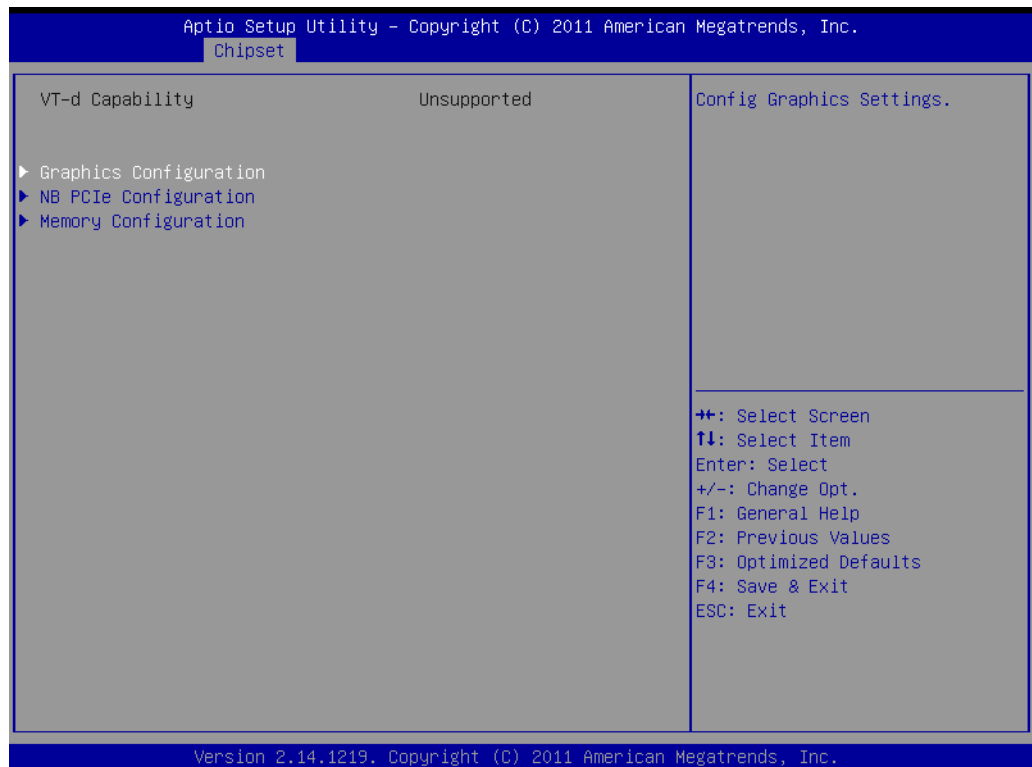

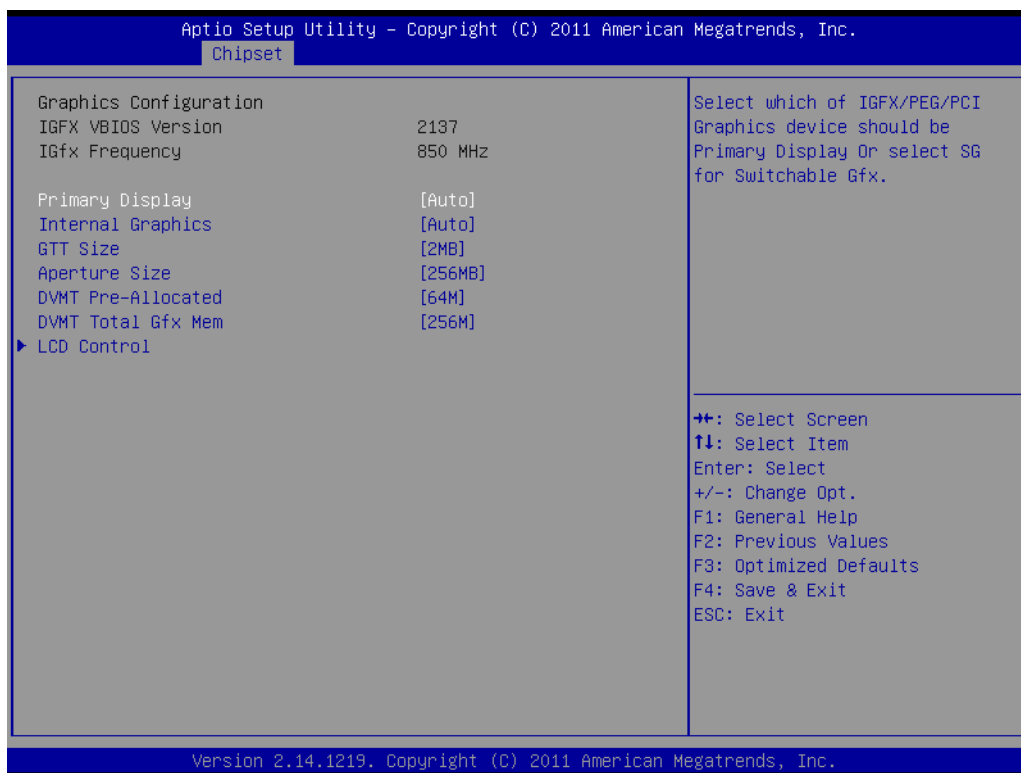

- **Primary Display**
This item allows users to select which graphics controller to use as the primary boot device.
- **Internal Graphics**
This item allows users to enable or disable IGD.
- **GTT Size**
This item allows users to select GTT size.
- **Aperture Size**
This item allows users to select aperture size.
- **DVMT Pre-Allocated**
This item allows users to select DVMT pre-allocated memory size.
- **DVMT Total Gfx Mem**
This item allows users to select DVMT total memory size.
- **LCD Control**
This item allows users to setup Display Control configuration.

3.4.4.1 LCD Control configuration

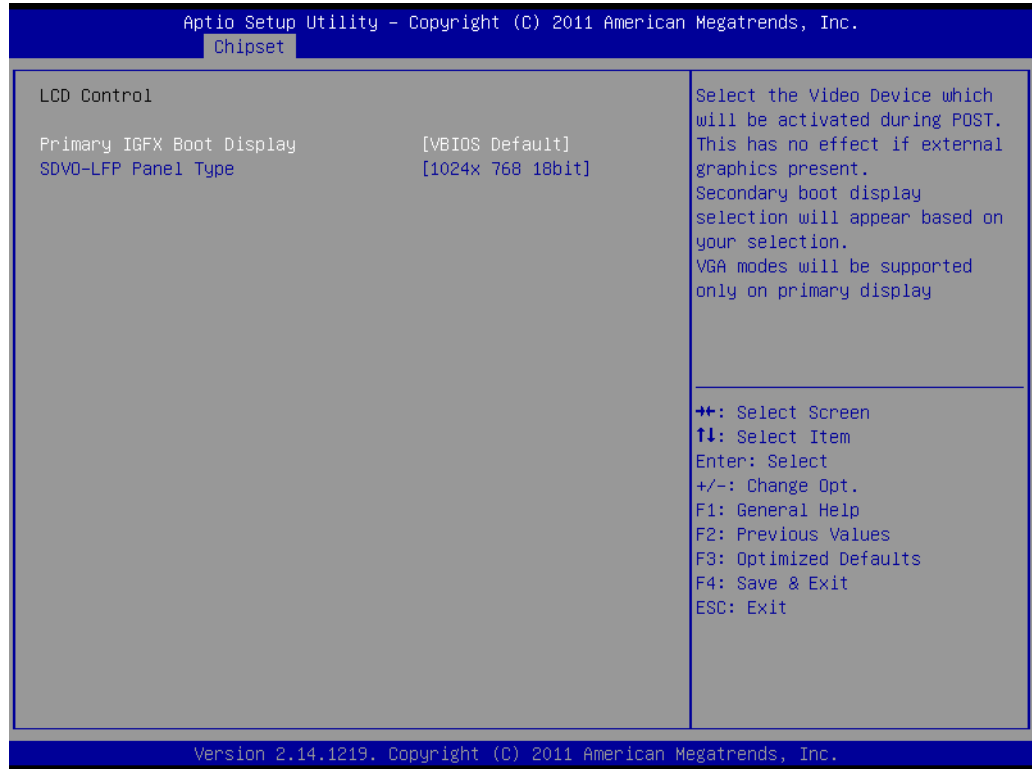

- **Primary IGFX Boot Display**
This items allow users to select the video device which will be activated during post. The available options are VBIOS Default, VGA1, LVDS/VGA2, DVI.
- **SDVO-LFP Panel Type:**
 - 1024 x 768 18-bit
 - 1024 x 768 24-bit
 - 1280 x 1024 48-bit
 - 1366 x 768 24-bit

3.4.5 NB PCIe Configuration

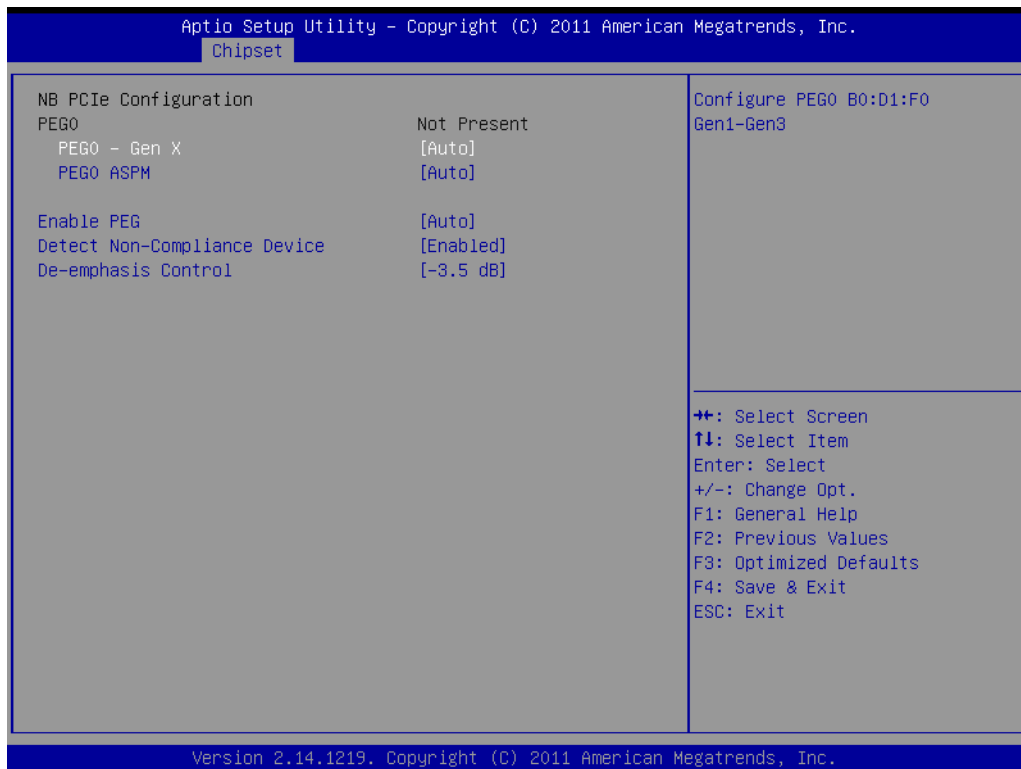

- **PEG0 - Gen x**
Select PEG0 speed.
 - PEG0 ASPM=> Enable/Disable PEG0 ASPM function. (ASPM: Active State Power Management)
- **Enable PEG**
This item allows users to enable or disable PEG always.
- **Detect Non-Compliance Device**
This item allows users to enable or disable Detect Non-Compliance Device function.

3.4.6 Memory Information

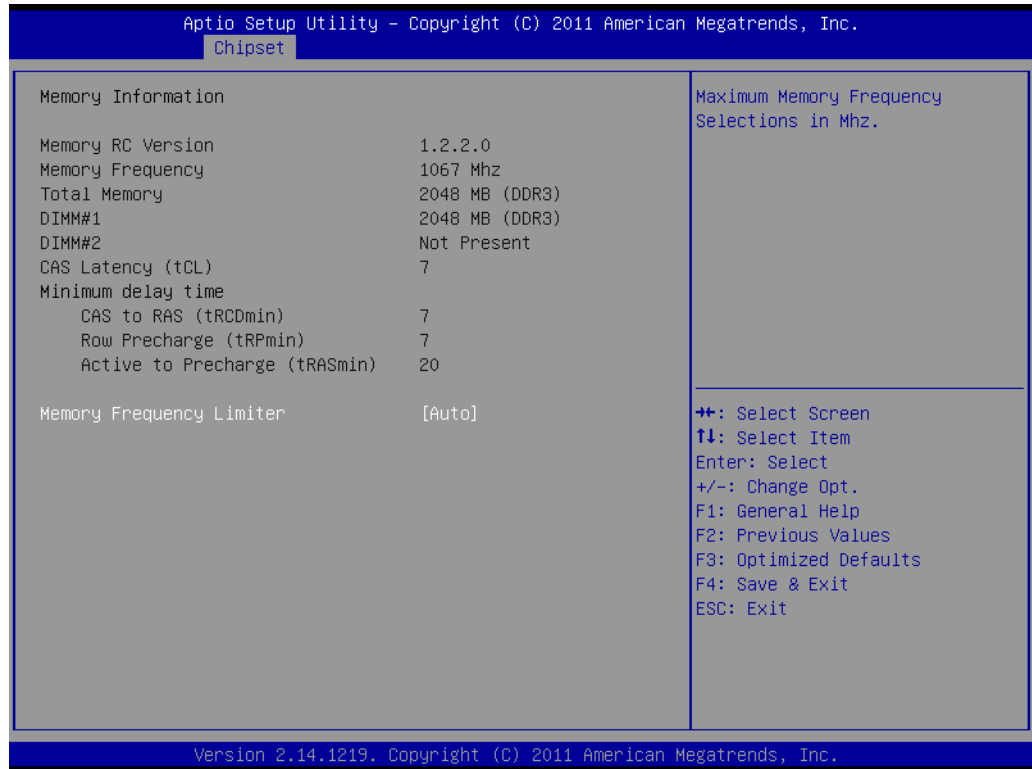

- **Memory Frequency Limiter**
Select memory frequency limiter for auto, 1067, 1333, 1600.

3.5 Boot Configuration

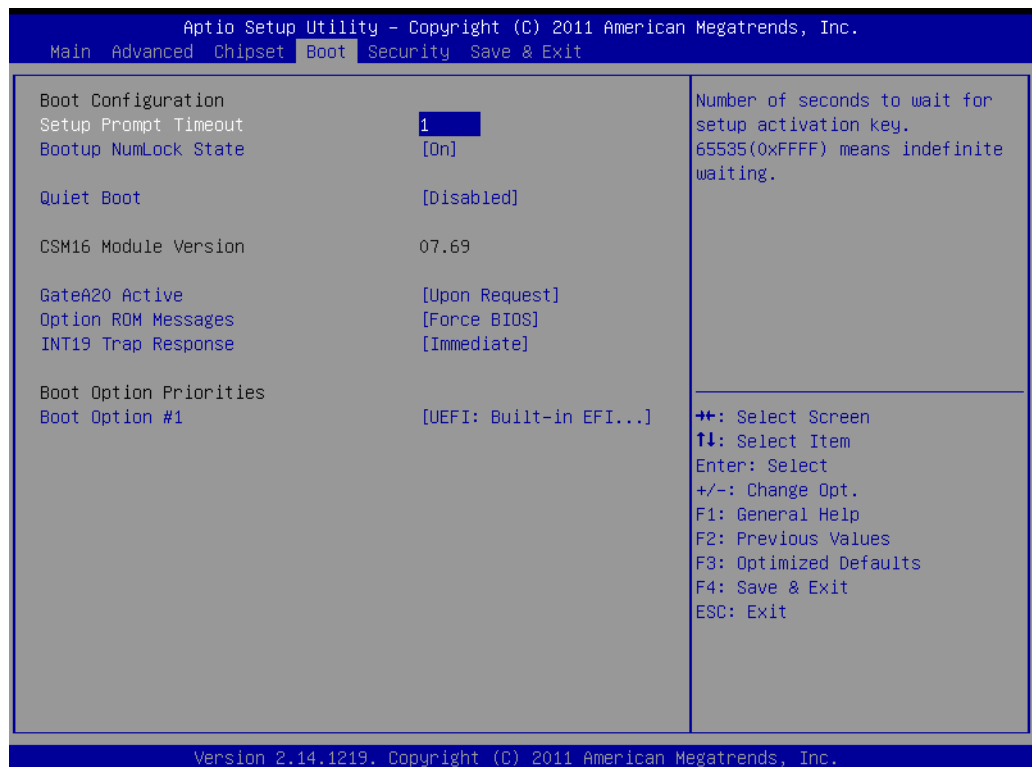

- **Setup Prompt Timeout**
This item allows you to change number of seconds to wait for setup activation key.
- **Bootup NumLock State**
Select the Power-on state for Numlock.
- **Quiet Boot**
If this option is set to Disabled, the BIOS display normal POST messages. If Enabled, an OEM Logo is shown instead of POST messages.
- **GateA20 Active**
This item allows you to select upon request or always.
- **Option ROM Messages**
Sets display mode for option ROM.
- **INT19 Trap Response**
This item allows option ROMs to trap interrupt 19.
- **Boot Option Priorities**
Set the system boot order.

3.6 Security Setting

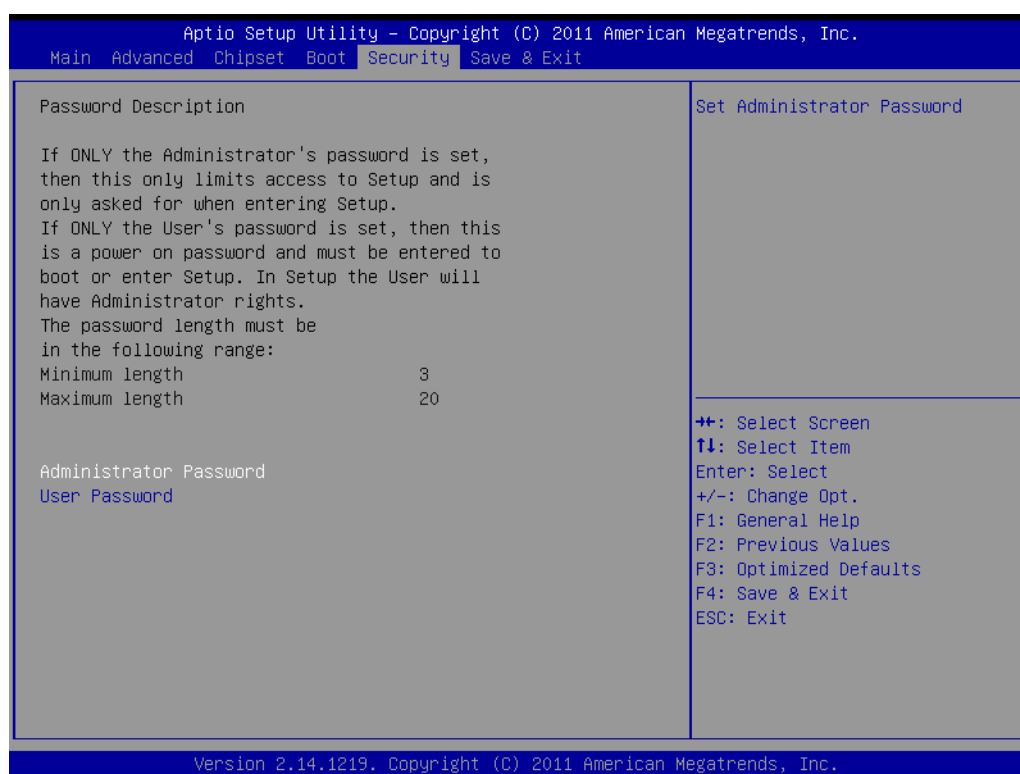

Select Security Setup from the AIMB-501 Setup main BIOS setup menu. All Security Setup options, such as password protection and virus protection are described in this section. To access the sub menu for the following items, select the item and press<Enter>: Change Administrator / User Password.

- **Administrator Password**
Select this option and press <ENTER> to access the sub menu, and then type in the password. Set the Administrator password.
- **User Password**

Select this option and press <ENTER> to access the sub menu, and then type in the password. Set the User Password.

3.7 Save & Exit Configuration

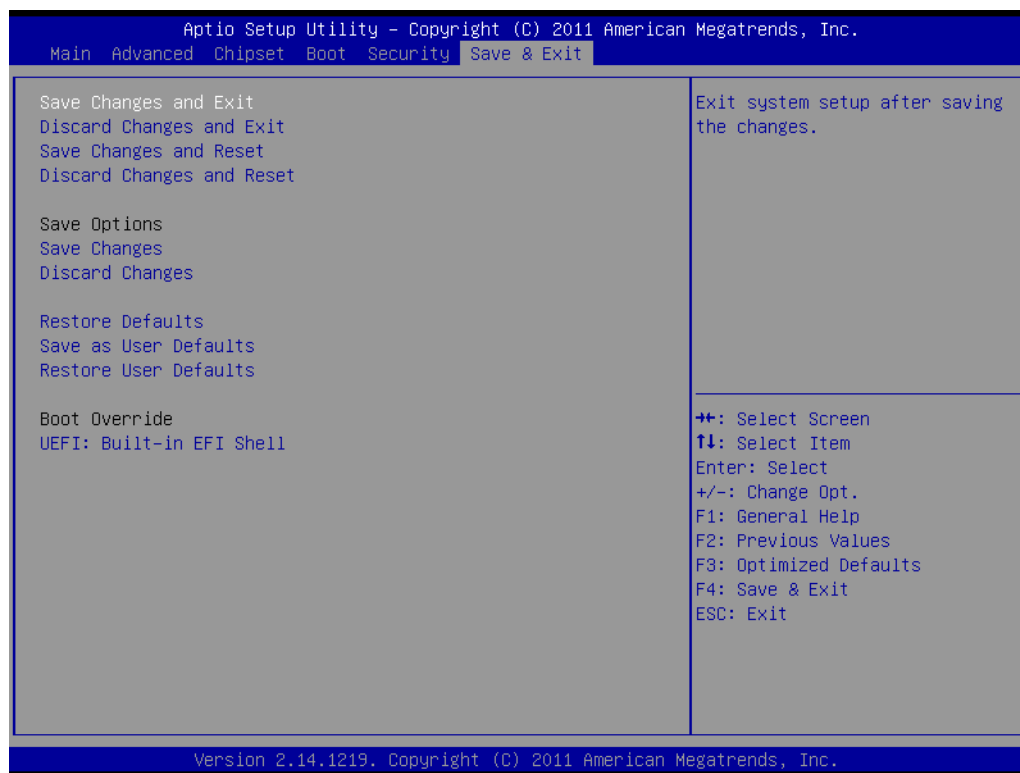

■ Save Changes and Exit

When users have completed system configuration, select this option to save changes, exit BIOS setup menu and reboot the computer to take effect all system configuration parameters.

1. Select Exit Saving Changes from the Exit menu and press <Enter>. The following message appears: Save Configuration Changes and Exit Now? [Ok] [Cancel]
2. Select Ok or cancel.

■ Discard Changes and Exit

Select this option to quit Setup without making any permanent changes to the system configuration.

1. Select Exit Discarding Changes from the Exit menu and press <Enter>. The following message appears: Discard Changes and Exit Setup Now? [Ok] [Cancel]
2. Select Ok to discard changes and exit. Discard Changes
Select Discard Changes from the Exit menu and press <Enter>.

■ Restore Default

The BIOS automatically configures all setup items to optimal settings when users select this option. Defaults are designed for maximum system performance, but may not work best for all computer applications. In particular, do not use the Defaults if the user's computer is experiencing system configuration problems. Select Restore Defaults from the Exit menu and press <Enter>.

■ Save as User Default

Save the all current settings as a user default.

■ Restore User Default

Restore all settings to user default values.

- **Boot Override**

Shows the boot device types on the system.

Chapter 4

Chipset Software
Installation Utility

4.1 Before You Begin

To facilitate the installation of the enhanced display drivers and utility software, read the instructions in this chapter carefully. The drivers for AIMB-501 are located on the software installation CD. The driver in the folder of the driver CD will guide and link you to the utilities and drivers under a Windows system. Updates are provided via Service Packs from Microsoft*.

Note! *The files on the software installation CD are compressed. Do not attempt to install the drivers by copying the files manually. You must use the supplied SETUP program to install the drivers.*



Before you begin, it is important to note that most display drivers need to have the relevant software application already installed in the system prior to installing the enhanced display drivers. In addition, many of the installation procedures assume that you are familiar with both the relevant software applications and operating system commands. Review the relevant operating system commands and the pertinent sections of your application software's user manual before performing the installation.

4.2 Introduction

The Intel Chipset Software Installation (CSI) utility installs the Windows INF files that outline to the operating system how the chipset components will be configured. This is needed for the proper functioning of the following features:

- Core PCI PnP services
- IDE Ultra ATA 100/66/33 and Serial ATA interface support
- USB 1.1/2.0 support (USB 2.0 driver needs to be installed separately for Win98)
- Identification of Intel chipset components in the Device Manager

Note! *This utility is used for the following versions of Windows, and it has to be installed **before** installing all the other drivers:*



- *Windows 7 (32-bit)*
- *Windows 7 (64-bit)*
- *Windows XP professional edition (32-bit)*
- *Windows XP professional edition (64-bit)*

4.3 Windows XP/Windows 7 Driver Setup

1. Insert the driver CD into your system's CD-ROM drive. You can see the driver folder items. Navigate to the "Intel chip" folder and click "Setup.exe" to complete the installation of the driver.

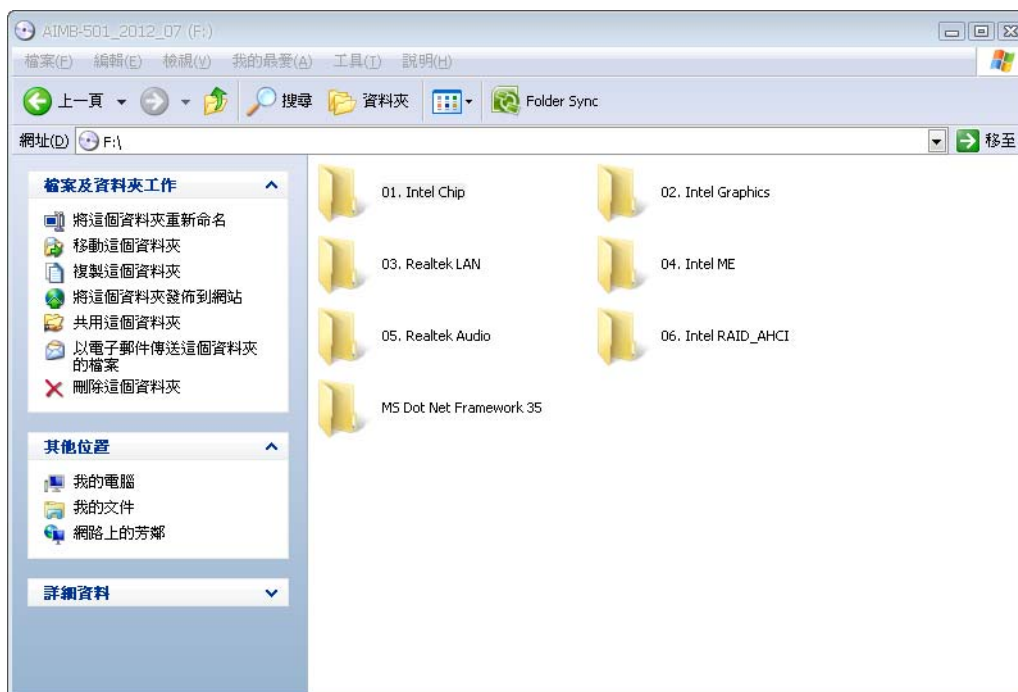

Chapter 5

VGA Setup

5.1 Introduction

The Intel Core i7-3770, Core i5-3550S, Core i3-3220, Core i7-2600, Core i5-2400, Core i3-2120, Pentium G850, Celeron G540 CPUs with dual cores are embedded with an integrated graphics controller. You need to install the VGA driver to enable this function.

Optimized integrated graphic solution: With Intel Graphics Flexible, versatile display options and 32-bit 3D graphics engine are supported. Dual independent displays and enhanced display modes for widescreen flat panels include extended, twin, and clone dual display modes, plus optimized 3D support delivers an intensive and realistic visual experience.

5.2 Windows 7/XP

Note! *Before installing this driver, make sure the CSI utility has been installed in your system. See Chapter 5 for information on installing the CSI utility.*



Insert the driver CD into your system's CD-ROM drive. Navigate to the "Intel Graphics" folder and click "setup.exe" to complete the installation of the drivers for Windows 7 and Windows XP.

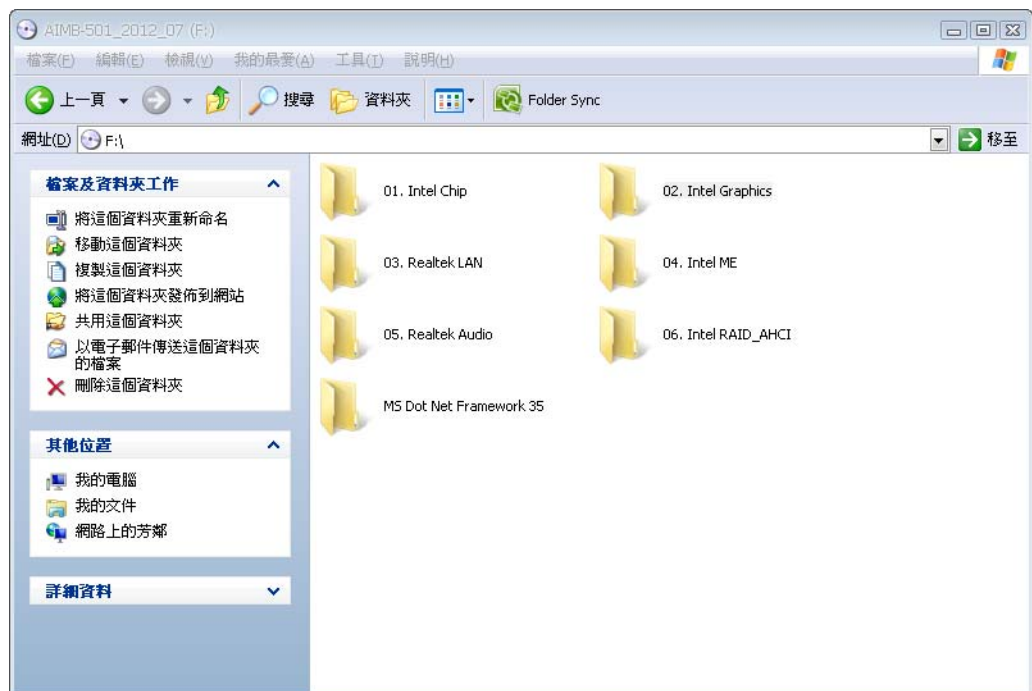

Chapter 6

LAN Configuration

6.1 Introduction

The AIMB-501 has dual Gigabit Ethernet LANs via dedicated PCI Express x1 lanes (Realtek RTL8111E-VL (LAN1) and Realtek RTL8111E-VL (LAN2)) that offer bandwidth of up to 500 MB/sec, eliminating the bottleneck of network data flow and incorporating Gigabit Ethernet at 1000 Mbps.

6.2 Installation

Note! Before installing the LAN drivers, make sure the CSI utility has been installed on your system. See Chapter 5 for information on installing the CSI utility.



The AIMB-501's Realtek RTL8111E-VL (LAN1) and Realtek RTL8111E-VL (LAN2) Gigabit integrated controllers support all major network operating systems. However, the installation procedure varies from system to system. Please find and use the section that provides the driver setup procedure for the operating system you are using.

6.3 Windows® 7/XP Driver Setup (Realtek RTL8111E-VL)

Insert the driver CD into your system's CD-ROM drive. Select the LAN folder then navigate to the directory for your OS.

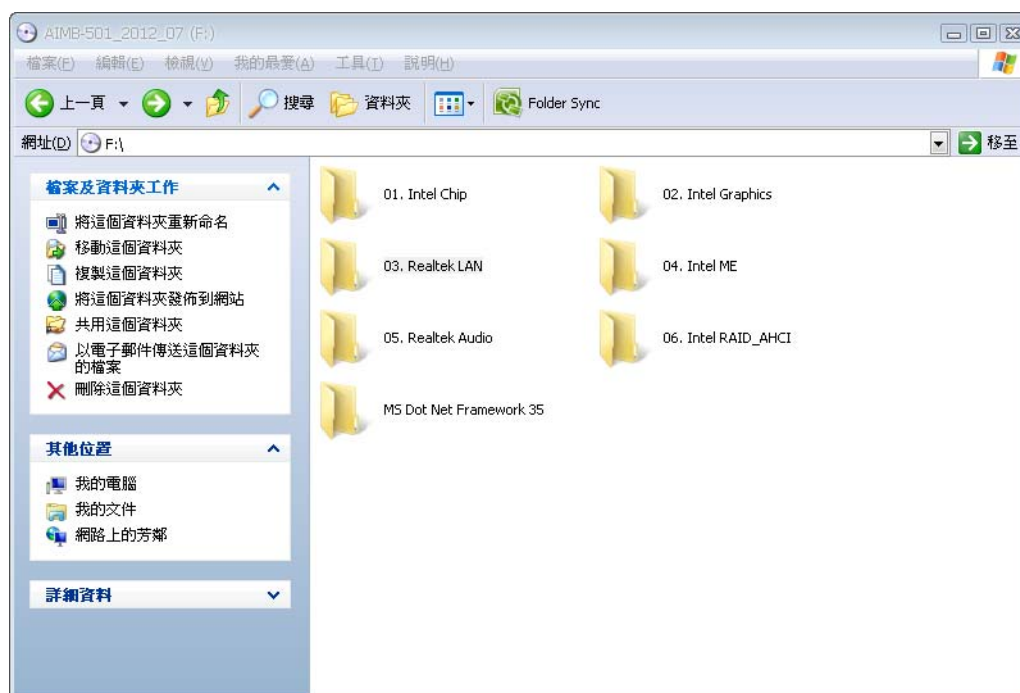

Appendix **A**

Programming the
Watchdog Timer

A.1 Programming the Watchdog Timer

AIMB-501's watchdog timer can be used to monitor system software operation and take corrective action if the software fails to function within the programmed period. This section describes the operation of the watchdog timer and how to program it.

A.1.1 Watchdog Timer Overview

The watchdog timer is built into the super I/O controller Nuvoton NCT6776F. It provides the following user-programmable functions:

- Can be enabled and disabled by user program
- Timer can be set from 1 to 255 seconds or 1 to 255 minutes
- Generates an interrupt or resets signal if the software fails to reset the timer before time-out

A.1.2 Programming the Watchdog Timer

The I/O port address of the watchdog timer is 2E (hex) and 2F (hex). 2E (hex) is the address port. 2F (hex) is the data port. You must first assign the address of register by writing an address value into address port 2E (hex), then write/read data to/from the assigned register through data port 2F (hex).

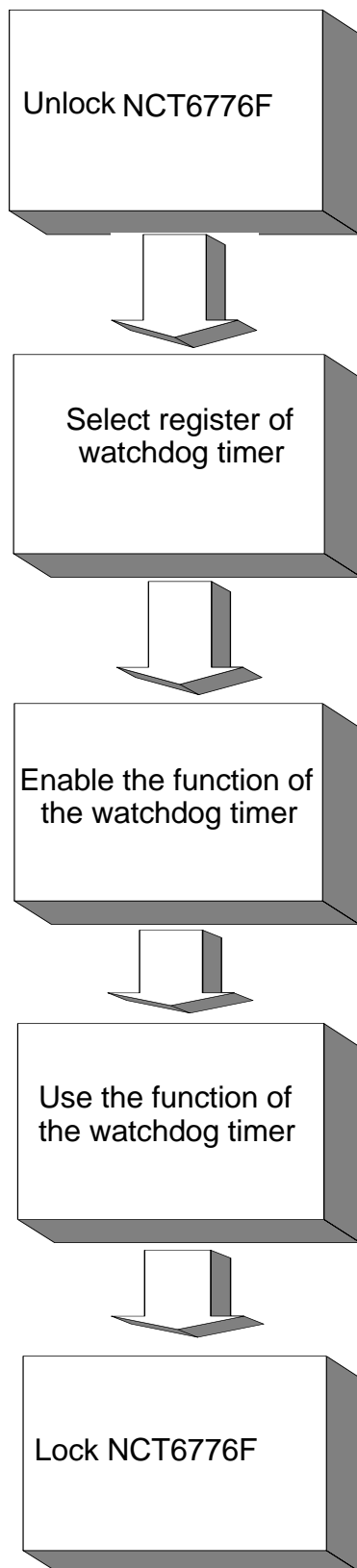

Table A.1: Watchdog Timer Registers

Address of Register (2E)	Attribute	Value (2F) & description
87 (hex)	-----	Write this address to I/O address port 2E (hex) twice to unlock the NCT6776F.
07 (hex)	write	Write 08 (hex) to select register of watchdog timer.
30 (hex)	write	Write 01 (hex) to enable the function of the watchdog timer. Disabled is set as default.
F5 (hex)	write	Set seconds or minutes as units for the timer. Write 0 to bit 3: set second as counting unit. [default] Write 1 to bit 3: set minutes as counting unit.
F6 (hex)	write	0: stop timer [default] 01~FF (hex): The amount of the count, in seconds or minutes, depends on the value set in register F5 (hex). This number decides how long the watchdog timer waits for strobe before generating an interrupt or reset signal. Writing a new value to this register can reset the timer to count with the new value.
F7 (hex)	read/write	Bit 7: Write 1 to enable mouse to reset the timer, 0 to disable [default]. Bit 6: Write 1 to enable keyboard to reset the timer, 0 to disable. [default] Bit 5: Write 1 to generate a timeout signal immediately and automatically return to 0. [default=0] Bit 4: Read status of watchdog timer, 1 means timer is "timeout".
AA (hex)	-----	Write this address to I/O port 2E (hex) to lock the watchdog timer 2.

A.1.3 Example Program

1. Enable watchdog timer and set 10 sec. as timeout interval

```

;-----
Mov dx,2eh ; Unlock NCT6776F
Mov al,87h
Out dx,al
Out dx,al
;-----
Mov al,07h ; Select registers of watchdog timer
Out dx,al
Inc dx
Mov al,08h
Out dx,al
;-----
Dec dx ; Enable the function of watchdog timer
Mov al,30h
Out dx,al
Inc dx
Mov al,01h
Out dx,al
;-----
Dec dx ; Set second as counting unit
Mov al,0f5h
Out dx,al
Inc dx
In al,dx
And al,not 08h
Out dx,al
;-----
Dec dx ; Set timeout interval as 10 seconds and start counting
Mov al,0f6h
Out dx,al
Inc dx
Mov al,10
Out dx,al
;-----
Dec dx ; Lock NCT6776F
Mov al,0aah
Out dx,al

```

2. Enable watchdog timer and set 5 minutes as timeout interval

```

;-----
Mov dx,2eh ; Unlock NCT6776F
Mov al,87h
Out dx,al
Out dx,al

```

```

;-----
Mov al,07h ; Select registers of watchdog timer
Out dx,al
Inc dx
Mov al,08h
Out dx,al
;-----
Dec dx ; Enable the function of watchdog timer
Mov al,30h
Out dx,al
Inc dx
Mov al,01h
Out dx,al
;-----
Dec dx ; Set minute as counting unit
Mov al,0f5h
Out dx,al
Inc dx
In al,dx
Or al,08h
Out dx,al
;-----
Dec dx ; Set timeout interval as 5 minutes and start counting
Mov al,0f6h
Out dx,al
Inc dx
Mov al,5
Out dx,al
;-----
Dec dx ; Lock NCT6776F
Mov al,0aah
Out dx,al
3. Enable watchdog timer to be reset by mouse
;-----
Mov dx,2eh ; Unlock NCT6776F
Mov al,87h
Out dx,al
Out dx,al
;-----
Mov al,07h ; Select registers of watchdog timer
Out dx,al
Inc dx
Mov al,08h
Out dx,al
;-----

```

```

Dec dx ; Enable the function of watchdog timer
Mov al,30h
Out dx,al
Inc dx
Mov al,01h
Out dx,al
;-----
Dec dx ; Enable watchdog timer to be reset by mouse
Mov al,0f7h
Out dx,al
Inc dx
In al,dx
Or al,80h
Out dx,al
;-----
Dec dx ; Lock NCT6776F
Mov al,0aah
Out dx,al
4. Enable watchdog timer to be reset by keyboard
;-----
Mov dx,2eh ; Unlock NCT6776F
Mov al,87h
Out dx,al
Out dx,al
;-----
Mov al,07h ; Select registers of watchdog timer
Out dx,al
Inc dx
Mov al,08h
Out dx,al
;-----
Dec dx ; Enable the function of watchdog timer
Mov al,30h
Out dx,al
Inc dx
Mov al,01h
Out dx,al
;-----
Dec dx ; Enable watchdog timer to be strobed reset by keyboard
Mov al,0f7h
Out dx,al
Inc dx
In al,dx
Or al,40h
Out dx,al

```

```

;-----
Dec dx ; Lock NCT6776F
Mov al,0aah
Out dx,al
5. Generate a time-out signal without timer counting
;-----
Mov dx,2eh ; Unlock NCT6776F
Mov al,87h
Out dx,al
Out dx,al
;-----
Mov al,07h ; Select registers of watchdog timer
Out dx,al
Inc dx
Mov al,08h
Out dx,al
;-----
Dec dx ; Enable the function of watchdog timer
Mov al,30h
Out dx,al
Inc dx
Mov al,01h
Out dx,al
;-----
Dec dx ; Generate a time-out signal
Mov al,0f7h
Out dx,al ;Write 1 to bit 5 of F7 register
Inc dx
In al,dx
Or al,20h
Out dx,al
;-----
Dec dx ; Lock NCT6776F
Mov al,0aah
Out dx,al

```

Appendix **B**

I/O Pin Assignments

B.1 LAN&USB Connector (LAN1_USB12, LAN2_USB34)

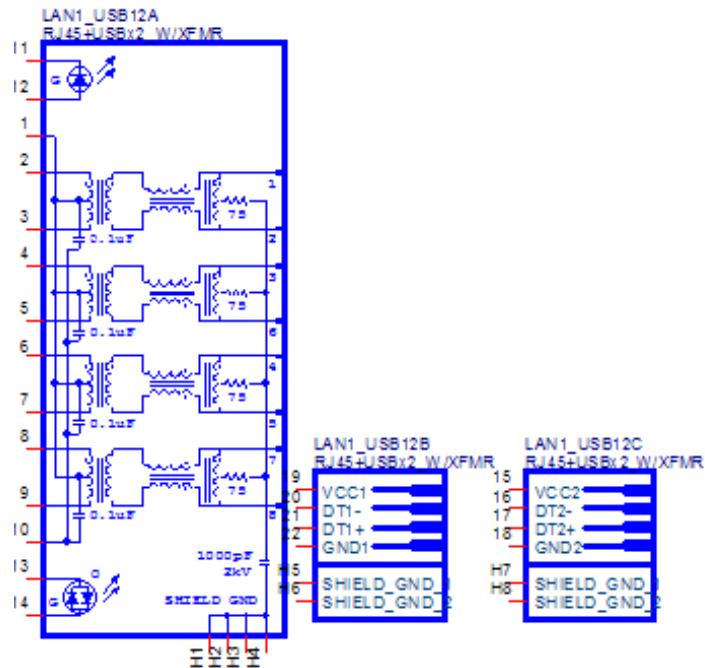

Table B.1: LAN&USB Connector (LAN1_USB12, LAN2_USB34)

LAN1_USB12, LAN2_USB34	LAN&USB Connector
Part Number	12GA1652003674
Pin	Pin Name
1	GND
2	LAN_MDI0_P
3	LAN_MDI0_N
4	LAN_MDI1_P
5	LAN_MDI1_N
6	LAN_MDI2_P
7	LAN_MDI2_N
8	LAN_MDI3_P
9	LAN_MDI3_N
10	GND
11	LAN_ACT#
12	LAN_ACTP
13	LINKLED#_N
14	LINKLED#_Q
15	+USBV89
16	LP9-
17	LP9+
18	GND
19	+USBV89
20	LP8-
21	LP8+
22	GND

B.2 USB Connector (USB01/23/45)

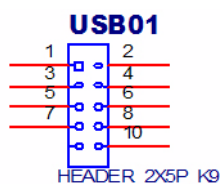

Table B.2: USB Connector (USB01/23/45)

USB01/23/45	USB connector
Part Number	12GP06-016R000
Pin	Pin Name
1	+USBV01
2	+USBV01
3	LP0-
4	LP1-
5	LP0+
6	LP1+
7	GND
8	GND
9	NC
10	GND

B.3 USB/PS2 KBMS Power Setting (DUALPWR3/DUALPWR2)

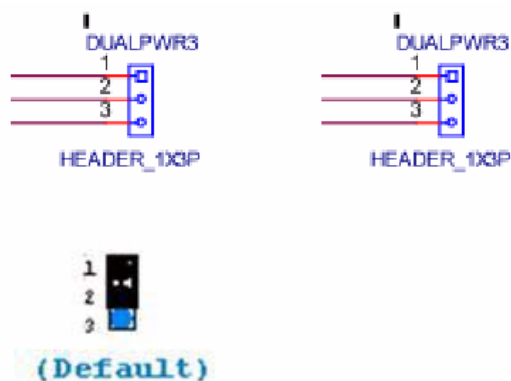

Table B.3: USB/PS2 KBMS Power Setting (DUALPWR3/DUALPWR2)

DUALPWR3/DUALPWR2	USB/PS2 KBMS Power Setting
Setting	Function
Pin	Pin Name
1-2	USB/PS2 KBMS power from MOS
2-3	USB/PS2 KBMS power from +5V

DUALPWR2- Jumper for on board USB

DUALPWR3- Jumper for rear side USB & PS/2 KBMS

B.4 VGA connector (VGA1/VGA2)

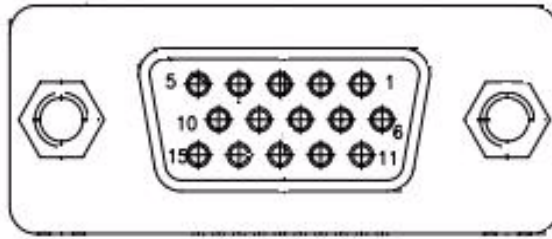

Table B.4: USB Connector (USB01/23/45)

VGA1/VGA2	VGA Connector
Part Number	12G101152158
Pin	Pin Name
1	RED
2	GREEN
3	BLUE
4	NC
5	GND
6	GND
7	GND
8	GND
9	VCC
10	GND
11	NC
12	DATA
13	HSYNC
14	VSYNC
15	DCLK
16	GND
17	GND

B.5 DVI Connector (DVI1)

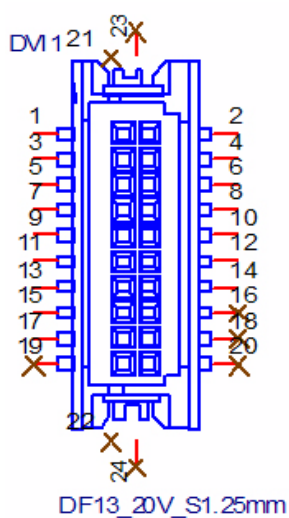

Table B.5: DVI Connector (DVI1)

DVI1	DVI Connector
Part Number	12GS1600030H03
Pin	Pin Name
1	DVI_TMDS_DATA0_N
2	+5V_DVI
3	DVI_TMDS_DATA0_P
4	DVI_TMDS_CLK_P
5	GND
6	DVI_TMDS_CLK_N
7	DVI_TMDS_DATA1_N
8	GND
9	DVI_TMDS_DATA1_P
10	TMDS1_DDC_SC
11	GND
12	TMDS1_DDC_SD
13	DVI_TMDS_DATA2_N
14	TMDS1_HPD
15	DVI_TMDS_DATA2_P
16	NC
17	+5V_DVI
18	NC
19	NC
20	NC

B.6 COM Port Connector (COM1/COM2)

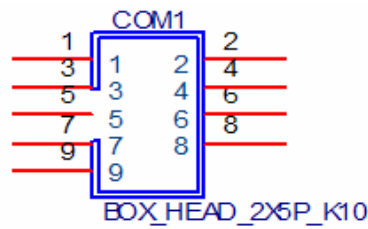

Table B.6: COM Port Connector (COM1/COM2)

COM1/COM2	COM Port Connector
Part Number	12G07120010T
Pin	Pin Name
1	DDCD1#
2	DDSR1#
3	RRXD1
4	RRTS1#
5	TTXD1
6	CCTS1#
7	DDTR1#
8	COM1_RRI1
9	GND

B.7 COM Port Connector (COM3456/COM78910)

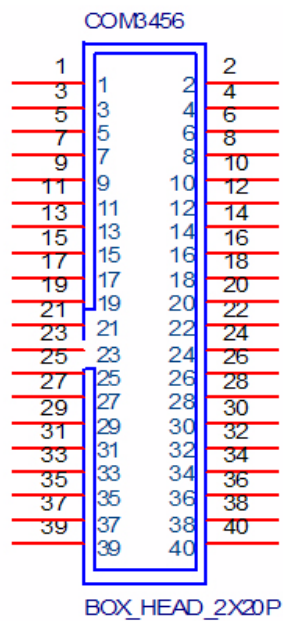

Table B.7: COM Port Connector (COM3456/COM78910)

COM1/COM2	COM Port Connector
Part Number	12G07120010T
Pin	Pin Name
1	COM3_1
2	DDSR3#
3	COM3_2
4	RRTS3#
5	COM3_3
6	CCTS3#
7	COM3_4
8	RRI3#
9	GND
10	GND
11	DDCD4#
12	DDSR4#
13	RRXD4
14	RRTS4#
15	TTXD4
16	CCTS4#
17	DDTR4#
18	RRI4#
19	GND
20	GND
21	DDCD5#
22	DDSR5#
23	RRXD5
24	RRTS5#
25	TTXD5
26	CCTS5#
27	DDTR5#
28	RRI5#
29	GND
30	GND
31	DDCD6#
32	DDSR6#
33	RRXD6
34	RRTS6#
35	TTXD6
36	CCTS6#
37	DDTR6#
38	RRI6#
39	GND
40	GND

B.8 KB/MS Connector (KBMS1)

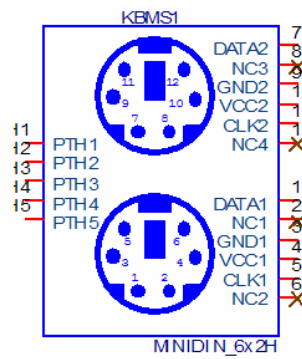

Table B.8: KB/MS Connector (KBMS1)

KBMS1	KB/MS Connector
Part Number	12G14101306P
Pin	Pin Name
1	CKBDATA
2	NC
3	GND
4	+5V_KBMS
5	CKBCLK
6	NC
7	CMSDATA
8	NC
9	GND
10	+5V_KBMS
11	CMSCLK
12	NC

B.9 KB/MS Header (KBMS2)



Table B.9: KB/MS Header (KBMS2)

KBMS2	KB/MS Header
Part Number	12GA1655006020
Pin	Pin Name
1	CKBCLK
2	CKBDATA
3	CMSDATA
4	GND
5	+5V_KBMS
6	CMSCLK

B.10 CPU FAN Connector (CPU FAN1)

You can use an LED to indicate when the single board computer is on. Pin 1 of JFP3 supplies the LED's power, and Pin 3 is the ground.

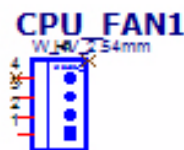

Table B.10: CPU FAN Connector (CPU FAN1)

CPU FAN1	CPU FAN Connector
Part Number	12G08000504A
Pin	Pin Name
1	GND
2	CPU_SFAN_PWR
3	CPU_SFAN_D
4	NC

B.11 System Fan Connector (SYS FAN1/SYS FAN2)

You can use an LED to indicate when the single board computer is on. Pin 1 of JFP3 supplies the LED's power, and Pin 3 is the ground.

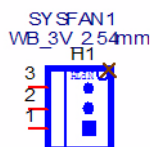

Table B.11: System Fan Connector (SYS FAN1/SYS FAN2)

SYS FAN1/SYS FAN2	System Fan Connector
Part Number	12G08002003C
Pin	Pin Name
1	GND
2	SYS1_SFAN_PWR
3	SYS1_SFAN_D

B.12 Front Panel Connector (JFP1+JFP2)

The single board computer has its own buzzer. You can also connect it to the external speaker on your computer chassis.

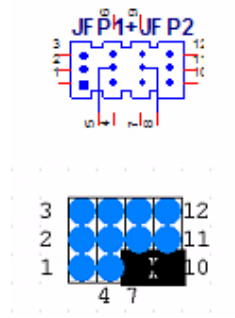

Table B.12: Front Panel Connector (JFP1+JFP2)

JFP1+JFP2	Front Panel Connector
Part Number	12GA1653004300
Pin	Pin Name
1	+5V
2	+3P3V
3	O_PWRBTN#IN
4	SPK_CN17P2
5	ICH_SATALED#
6	GND
7	SPK_CN17P4
8	SNMP_SDA
9	FP_SYS_RST#
10	SPK_CN17P3
11	SNMP_SCL
12	GND

B.13 Front Panel Connector (JFP3)

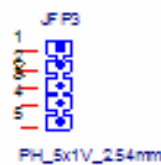

Table B.13: Front Panel Connector (JFP3)

JFP3	Front Panel Connector
Part Number	12G06000005C
Pin	Pin Name
1	SIO_SUSLED
2	NC
3	GND
4	#KEYLOCK
5	GND

Note: Pin1,3 provide LED function ; Pin4,5 provide the ability to lock PS/2 (KBMS) .

B.14 Audio jack (AUDIO1)

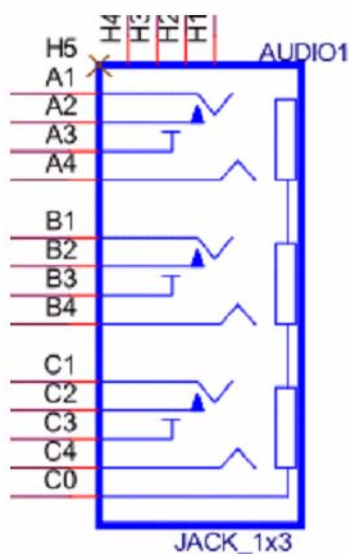

Table B.14: Audio Jack (AUDIO1)

AUDIO1	Audio Jack
Part Number	12GS2400005F04
Pin	Pin Name
A1	LIN1_L
A2	LIN1_JD
A3	GND
A4	LIN1_R
B1	FRONT_L
B2	FRONT_JD
B3	GND
B4	FRONT_R
C1	MIC1_L
C2	MIC1_JD
C3	GND
C4	MIC1_R
C0	GND

B.15 SM BUS Connector (SMBUS1)

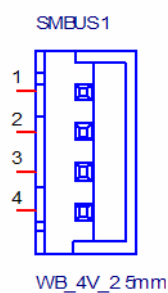

Table B.15: SM BUS Connector (SMBUS1)

SMBUS1	SM BUS Connector
Part Number	12GA1655001154
Pin	Pin Name
1	+5V
2	SMB_CLK_MAIN
3	SMB_DATA_MAIN
4	GND

B.16 SATA Connector (SATA1/2/3/4)

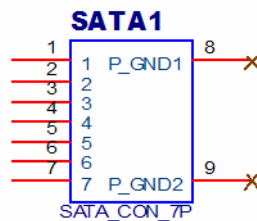

Table B.16: SATA Connector (SATA1/2/3/4)

SATA1/2/3/4	SATA Connector
Part Number	12GP24-006R000
Pin	Pin Name
1	GND
2	SATA_TXP0_C
3	SATA_TXN0_C
4	GND
5	SATA_RXN0_C
6	SATA_RXP0_C
7	GND

B.17 VOLT Connector (VOLT1)

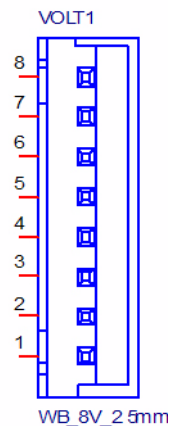
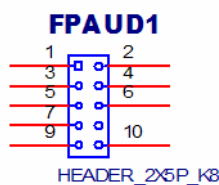

Table B.17: VOLT Connector (VOLT1)

VOLT1	VOLT Connector
Part Number	12GA1655008020
Pin	Pin Name
1	+5VA
2	GND
3	GND
4	-5V
5	+5V
6	+3P3V
7	-12V
8	+12V

B.18 Front Audio Header (FPAUD1)

**Table B.18: Front Audio Header (FPAUD1)**

FPAUD1	Front Audio Header
Part Number	12G06105010V
Pin	Pin Name
1	MIC2_L
2	GND
3	MIC2_R
4	F_AUDIO_DET#
5	LIN2_R
6	MIC2_JD
7	SENSE_B
8	NC
9	LIN2_L
10	LIN2_JD

B.19 ATX 24-pin Power Connector (EATXPWR1)

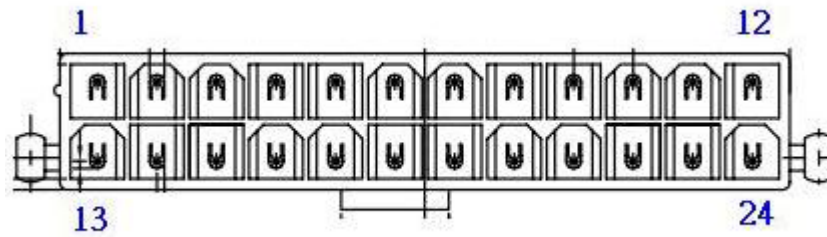

Table B.19: ATX 24-pin Power Connector (EATXPWR1)

EATXPWR1	ATX 24-pin Power Connector
Part Number	12G15020024J
Pin	Pin Name
1	+3.3V
2	+3.3V
3	GND
4	+5V
5	GND
6	+5V
7	GND
8	PWROK
9	5VSB
10	+12V
11	+12V
12	+3.3V
13	+3.3V
14	-12V
15	GND
16	PSON#
17	GND
18	GND
19	GND
20	-5V
21	+5V
22	+5V
23	+5V
24	GND

B.20 ATX 4-pin Power Connector (ATX12V1)

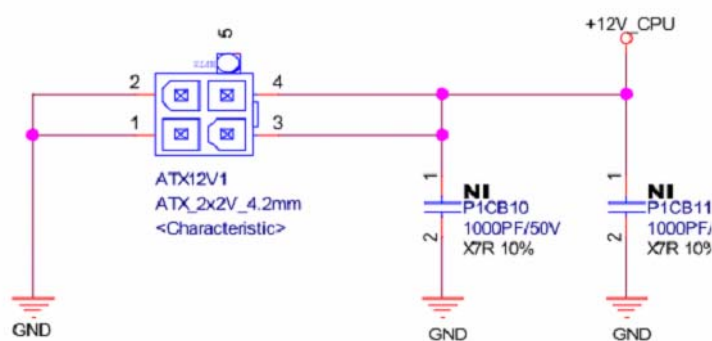

Table B.20: ATX 4-pin Power Connector (ATX12V1)

ATX12V1	ATX 4-pin Power Connector
Part Number	12G150200047
Pin	Pin Name
1	GND
2	GND
3	+12V_CPU
4	+12V_CPU

B.21 SPI Connector (SPI_CN1)

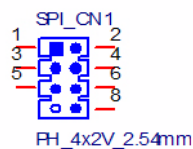

Table B.21: SPI Connector (SPI_CN1)

SPI_CN1	SPI Connector
Part Number	12G06100008T
Pin	Pin Name
1	SPI_POWER
2	GND
3	SPI_CS#
4	SPI_CLK
5	SPI_MISO
6	SPI_MOSI
7	NC
8	SPI_HOLD#

B.22 Inverter Power Output (INV1)

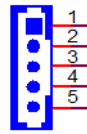

Table B.22: Inverter Power Output (INV1)

INV1	Inverter Power Output
Part Number	12GA1655000453
Pin	Pin Name
1	+12V
2	GND
3	ENABKL
4	VBR
5	+5V

B.23 LVDS Connector (LVDS1)

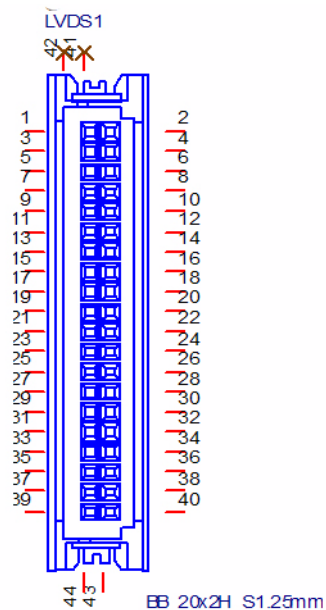

Table B.23: LVDS Connector (LVDS1)

LVDS1	LVDS connector
Part Number	12GS1600024H03
Pin	Pin Name
1	VDD_LVDS1
2	VDD_LVDS1
3	GND
4	GND
5	VDD_LVDS1

6	VDD_LVDS1
7	LVDS1_A0N
8	LVDS1_A4N
9	LVDS1_A0P
10	LVDS1_A4P
11	GND
12	GND
13	LVDS1_A1N
14	LVDS1_A5N
15	LVDS1_A1P
16	LVDS1_A5P
17	GND
18	GND
19	LVDS1_A2N
20	LVDS1_A6N
21	LVDS1_A2P
22	LVDS1_A6P
23	GND
24	GND
25	LVDS1_CLK1
26	LVDS1_CLK2N
27	LVDS1_CLK1P
28	LVDS1_CLK2P
29	GND
30	GND
31	LVDS1_SCD
32	LVDS1_SDD
33	GND
34	GND
35	LVDS1_A3N
36	LVDS1_A7N
37	LVDS1_A3P
38	LVDS1_A7P
39	LVDS1_ENBKL1
40	LVDS1_VCON

B.24 GPIO Connector (GPIO1)

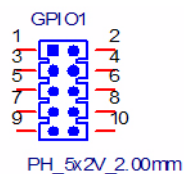
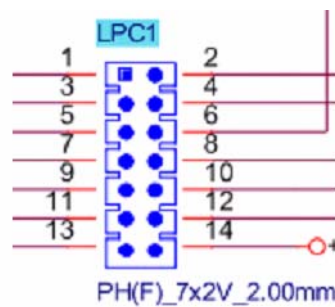

Table B.24: GPIO Connector (GPIO1)

GPIO1	GPIO Connector
Part Number	12G061100107
Pin	Pin Name
1	SIO_GPIO0
2	SIO_GPIO1
3	SIO_GPIO2
4	SIO_GPIO3
5	SIO_GPIO4
6	SIO_GPIO5
7	SIO_GPIO6
8	SIO_GPIO7
9	VCC_GPIO
10	GND

B.25 Debug Port (LPC1)

**Table B.25: Debug Port (LPC1)**

LPC1	Debug Port
Part Number	12GA1653007220
Pin	Pin Name
1	CLK_PCI_P80
2	LAD1
3	PLTRST#
4	LAD0
5	LFRAME#
6	+3P3V
7	LAD3
8	GND
9	LAD2
10	SMB_CLK_MAIN
11	SERIRQ
12	SMB_DATA_MAIN
13	+5V_DUAL
14	+5V

B.26 DMA Channel Assignments

Table B.26: DMA Channel Assignments

Channel	Function
0	Available
1	Available
2	Available
3	ECP Printer Port (LPT1)
4	Cascade for DMA controller 1
5	Available
6	Available
7	Available

B.27 Interrupt Assignments

Table B.27: Interrupt Assignments

Priority	Interrupt#	Interrupt source
1	NMI	Parity error detected
2	IRQ0	Interval timer
3	IRQ1	Keyboard
-	IRQ2	Interrupt from controller 2 (cascade)
4	IRQ8	Real-time clock
5	IRQ9	Cascaded to INT 0A (IRQ 2)
6	IRQ10	Serial communication port 3/4/5/6
7	IRQ11	Serial communication port 7/8/9/10
8	IRQ12	PS/2 mouse
9	IRQ13	INT from co-processor
10	IRQ14	Primary IDE Channel
11	IRQ15	Secondary IDE Channel
12	IRQ3	Serial communication port 2
13	IRQ4	Serial communication port 1
14	IRQ5	Available
15	IRQ6	Available
16	IRQ7	Parallel port 1 (print port)

B.28 1st MB Memory Map

Table B.28: 1st MB Memory Map

Addr. range (Hex)	Device
E0000h - FFFFFh	BIOS
CC000h - DFFFFh	Unused
C0000h - CBFFFh	VGA BIOS
A0000h - BFFFFh	Video Memory
00000h - 9FFFFh	Base memory

ADVANTECH

Enabling an Intelligent Planet

www.advantech.com

Please verify specifications before quoting. This guide is intended for reference purposes only.

All product specifications are subject to change without notice.

No part of this publication may be reproduced in any form or by any means, electronic, photocopying, recording or otherwise, without prior written permission of the publisher.

All brand and product names are trademarks or registered trademarks of their respective companies.

© Advantech Co., Ltd. 2012