

Quick Start Guide for the Limitless™ Series WGLA Limit Switch *used in conjunction with the Limitless™ WPMM Series*

ISSUE 1
50053338

WARNING

PERSONAL INJURY

DO NOT USE these products as safety or emergency stop devices or in any other application where failure of the product could result in personal injury.

Failure to comply with these instructions could result in death or serious injury.

WARNING

Honeywell does not recommend using devices for critical control applications where there is, or may be, a single point of failure or where single points of failure may result in an unsafe condition. It is up to the end-user to weigh the risks and benefits to determine if the products are appropriate for the application based on security, safety and performance. Additionally, it is up to the end-user to ensure that the control strategy results in a safe operating condition if any crucial segment of the control solution fails.

Honeywell customers assume full responsibility for learning and meeting the required Declaration of Conformity, Regulations, Guidelines, etc. for each country in their distribution market.

Failure to comply with these instructions could result in death or serious injury.

WARNING

RF EXPOSURE

To satisfy FCC RF exposure requirements for mobile transmitting devices, a separation distance of 20 cm or more should be maintained between the antenna of this device and persons during device operation. To ensure compliance, operation at closer than this distance is not recommended. The antenna used for this transmission must not be co-located in conjunction with any other antenna or transmitter.

Failure to comply with these instructions could result in death or serious injury.

WARNING

The WGLA must be installed in accordance with the requirements specified in this document. See Section 3 and Section 4 for EIRP requirements. Only the specified EIRP power settings, antenna types and gains and cable lengths (attenuation) as outlined in this document are valid for WGLA Series installations.

CAUTION

Power to the WGLA should not be applied (ensure battery is removed) during installation of antenna as damage could occur to the WGLA electronics.

This WGLA Series quick start installation guide provides basic installation instructions for the WGLA switch used in conjunction with a Limitless™ Wireless Panel Mount Monitor (WPMM). If necessary, refer to the WGLA or WPMM Installation and Technical Manual for further detailed information regarding installation.

1.1 Antenna Connection

 **WARNING**
RF EXPOSURE
To satisfy FCC RF exposure requirements for mobile transmitting devices, a separation distance of 20 cm [7.87 in] or more should be maintained between the antenna of this device and persons during device operation. To ensure compliance, operation at closer than this distance is not recommended. The antenna used for this transmission must not be co-located in conjunction with any other antenna or transmitter.
Failure to comply with these instructions could result in death or serious injury.

CAUTION
Power to the WGLA should not be applied (ensure battery is removed) during installation of antenna as damage could occur to the WGLA electronics.

The antenna and antenna guard are packaged separately and thus will need to be assembled to the WGLA.

A **direct mount antenna** (either straight or tilt & swivel) can be easily mounted by threading the mating RP-SMA plug of the antenna to the RP-SMA jack on the WGLA. Tighten the connection until finger tight. Then attach the antenna guard by simply threading the guard finger tight onto the threaded base with the RP-SMA connector.

A **remote mount antenna** requires the use of an extension cable to allow the antenna to be mounted in a different location than the WGLA location. The extension cable will need to have one end with a RP-SMA plug connector which will mate with the WGLA connector jack under the same mounting procedure as the direct mount antenna. The other end of the extension cable will need to mate with antenna connector directly.

1.2 Battery Connection Procedure

 **WARNING**
RISK OF DEATH OR SERIOUS INJURY FROM EXPLOSION OR FIRE
Connection and disconnection of the batteries should only be performed in a non-hazardous area. The batteries used in this device may present a risk of fire or chemical burn if mistreated. Do not recharge, disassemble, heat above 100 °C [212 °F], or incinerate.
Failure to comply with these instructions could result in death or serious injury.

 **WARNING**
RISK OF DEATH OR SERIOUS INJURY FROM EXPLOSION OR FIRE
If WGLA is to be returned to Honeywell for any reason, the battery **MUST** be removed prior to shipping. Dispose of used batteries promptly per local regulations or the battery manufacturer's recommendations. Keep away from children. Do not disassemble and do not dispose of in fire.
Failure to comply with these instructions could result in death or serious injury.

 **ATTENTION**
Use only the following 3.6V lithium thionyl chloride (Li-SOCl₂) battery (non-rechargeable), size 2/3AA. No other batteries are approved for use in the WGLA Series limit switch.
Uniwell, DEV-10-0009
Honeywell, WBT1

WGLA battery activation:

Tools required: Slotted or Phillips screwdriver

Step	Action
1	If applicable, remove the two screws ① on the housing cover.
2	Using a finger, press down slightly on the battery top ② and remove the battery insulator ③. Insure that the battery is properly seated and making good contact.
3	Replace cover and retighten screws or immediately proceed to Section 1.3 Pairing Mode.

Figure 1. Limitless™ Switch Housing



Figure 2. Limitless™ Battery and Insulator

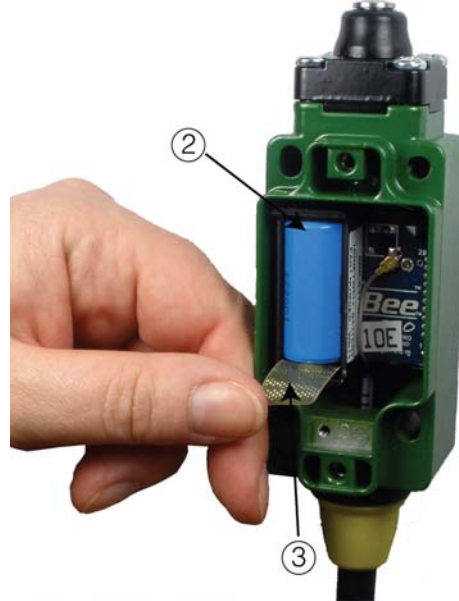

1.3 Pairing Mode

Pairing is required to initiate and establish an RF communication link between each single WGLA and a single WPMM. The WGLA will be shipped from the factory with two identification labels (1) that are recommended to be completed and applied to the WGLA housing during the pairing mode. As there are up to 16 WGLAs that can be paired to a single WPMM, these labels will be used to identify the WGLA switch in the sequence of #1 to #16. The initial WGLA switch paired to the WPMM will be Sequence #1; the second WGLA paired will be Sequence #2 and so on. If replacing a WGLA switch that has been purged (see section 6.5 of the WPMM Installation and Technical Manual), identify the correct replacement Sequence # on the identification labels.



ATTENTION

The operation and LED functions for the WPMM are visually depicted and described in Section 5.4 of the WGLA Installation and Technical manual. This file is also located as a separate file on this CD or at www.honeywell.com/sensing.



ATTENTION

The operation and LED functions for the WPMM are visually depicted and described in Section 5.4 of the WGLA Installation and Technical manual. This file is also located as a separate file on this CD or at www.honeywell.com/sensing.

The battery will need to be activated in the WGLA and proper power applied to the WPMM (green ② LED illuminated) before proceeding with this pairing procedure. Once the pairing is completed, the WGLA selected will only communicate with the WPMM it was paired to and no other device.

Step	Action
1	Completely read this procedure before starting in order to understand the timing of events that need to be performed.
2	WGLA: Remove (if required) the two screws ⑥ on the housing cover (See Figure 3) of the WGLA and locate the function button ⑦ to be used in Step 4.
3	WPMM: Press the Function button ④ on WPMM (See Figure 4) for more than four seconds and less than eight seconds at which time the green ② and amber ③ LEDs will be flashing which indicates to release the function button immediately as it has entered the pairing mode.
4	WGLA: Within a 30 second interval of Step 3, depress the WGLA switch function button ⑦ (See Figure 5) and hold depressed for more than one second and less than 12 seconds at which time the orange ⑧ LED turns on. While in pairing mode, the orange led will flash on for 100 ms every second. The orange ⑧ LED flashes three times 100 ms on, 100 ms off when pairing succeeds. If pairing does not succeed, the orange ⑧ LED will turn off and user will need to repeat steps starting with Step 3.
5	WPMM: Successful pairing will be indicated by the green ② and amber ③ LEDs (See Figure 4) ceasing to flash and remaining on for a few seconds before turning off. A short buzzer beep will also occur.
6	To confirm proper pairing between the WGLA and WPMM, actuate the WGLA, and the red LED ⑤ should illuminate along with a buzzer sound.
7	Record the WGLA Sequence # on identification labels ① and apply to the WGLA housing in desired locations (See Figure 6).
8	Repeat Steps 2-7 to add additional WGLA switches. Up to 16 WGLAs can be paired to a single WPMM.

Figure 3. Limitless™ Switch Housing

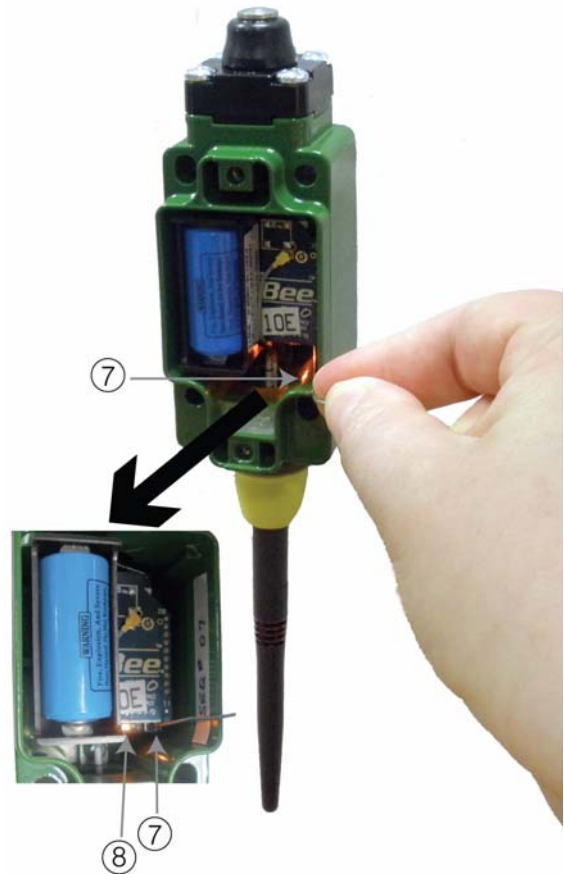

Figure 4. Limitless™ Switch Housing



NOTE: Use a blunt object, such as a paper clip or tooth pick to actuate the function switch ④.

Figure 5. Limitless™ Switch with Function Button Depressed



NOTE: Use a blunt object, such as a paper clip or tooth pick to actuate the function switch ⑦.

Figure 6. Limitless™ Switch Label Placement



1.4 WGLA Mounting

The WGLA housing has four mounting holes that will accept a M5 or #10 size screw. Two of the mounting holes are slotted to allow adjustment of the switch actuator to the customer actuator during installation. It is suggested that the two slotted holes have screws installed and adjustment be made before installing screws in the non-slotted holes.

Note: The adjustment process should not allow preload of the switch actuator and the full travel of the switch actuator should not exceed the switch over travel maximum specification. (See installation drawing at www.honeywell.com/sensing)

Figure 7. Limitless™ WGLA mounting hole diagram

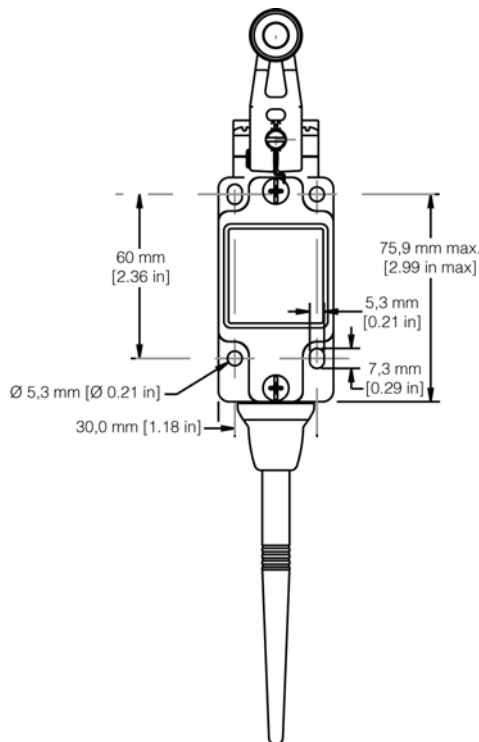

The WGLA Series switch has many actuator types and associated specifications. Additional information can be found at: www.honeywell.com/sensing

1.5 Antenna Adjustment

The antenna of the WGLA and WPMM should be oriented with respect to each other such that they are parallel. This will in most cases allow the longest range and highest RF communication link/signal. The least RF signal is normally in a direction in-line with the top of the antenna, so it is best to avoid having the antennas pointed directly toward each other, or directly away from each other. An acceptable RF signal is also indicated by the WPMM. This can be checked by making sure the red ⑤ LED turns on when the WGLA is actuated but the amber ③ LED is off.

Figure 8. Limitless™ WGLA and WPMM in parallel



Figure 9. Limitless™ WPMM LED display



NOTE: Use a blunt object, such as a paper clip or tooth pick to actuate the function switch ④.

⚠ WARNING

RF EXPOSURE

To satisfy FCC RF exposure requirements for mobile transmitting devices, a separation distance of 20 cm [7.87 in] or more should be maintained between the antenna of this device and persons during device operation. To ensure compliance, operations at closer than this distance is not recommended. The antenna used for this transmitter must not be co-located in conjunction with any other antenna or transmitter.

Failure to comply with these instructions could result in death or serious injury.

WARRANTY/REMEDY

Honeywell warrants goods of its manufacture as being free of defective materials and faulty workmanship. Honeywell's standard product warranty applies unless agreed to otherwise by Honeywell in writing; please refer to your order acknowledgement or consult your local sales office for specific warranty details. If warranted goods are returned to Honeywell during the period of coverage, Honeywell will repair or replace, at its option, without charge those items it finds defective. **The foregoing is buyer's sole remedy and is in lieu of all other warranties, expressed or implied, including those of merchantability and fitness for a particular purpose. In no event shall Honeywell be liable for consequential, special, or indirect damages.**

While we provide application assistance personally, through our literature and the Honeywell web site, it is up to the customer to determine the suitability of the product in the application.

Specifications may change without notice. The information we supply is believed to be accurate and reliable as of this printing. However, we assume no responsibility for its use.

SALES AND SERVICE

Honeywell serves its customers through a worldwide network of sales offices, representatives and distributors. For application assistance, current specifications, pricing or name of the nearest Authorized Distributor, contact your local sales office or:

E-mail: info.sc@honeywell.com

Internet: www.honeywell.com/sensing

Phone and Fax:

Asia Pacific	+65 6355-2828
	+65 6445-3033 Fax
Europe	+44 (0) 1698 481481
	+44 (0) 1698 481676 Fax
Latin America	+1-305-805-8188
	+1-305-883-8257 Fax
USA/Canada	+1-800-537-6945
	+1-815-235-6847
	+1-815-235-6545 Fax